

Service Manual–E2723HN
Regulatory model: E2723HNc

Version: 02
Date:2021/10/11

Content Index

1. General Safety Instructions	3
1.1 SAFETY: General Safety	3
1.2 SAFETY: General Power Safety	5
2. Exploded view diagram with list of items	6
3. Wiring connectivity diagram	8
4. How to connect and disconnect power cable/ connectivity cable.....	9
5. Disassembly and Assembly Procedures	11
5.1 Disassembly SOP	11
5.2 Assembly SOP	15
6. Trouble shooting instructions	

1. General Safety Instructions

Use the following safety guidelines to help ensure your own personal safety and to help protect your equipment and working environment from potential damage.

NOTE: In this section, equipment refers to monitors.

IMPORTANT NOTICE FOR USE IN HEALTHCARE ENVIRONMENTS:

Dell products are not medical devices and are not listed under UL or IEC 60601 (or equivalent). As a result, they must not be used within 6 feet of a patient or in a manner that directly or indirectly contacts a patient

1.1 SAFETY: General Safety

WARNING: To prevent the spread of fire, keep candles or other open flames away from this product at all times.

When setting up the equipment for use:

- Place the equipment on a hard, level surface. Leave 10.2 cm (4 in) minimum of clearance on all vented sides of the computer to permit the airflow required for proper ventilation.
- Restricting airflow can damage the computer or cause a fire.
- Do not stack equipment or place equipment so close together that it is subject to recirculated or preheated air.
- **NOTE:** Review the weight limits referenced in your computer documentation before placing a monitor or other devices on top of your computer.
- Ensure that nothing rests on your equipment's cables and that the cables are not located where they can be stepped on or tripped over.
- Ensure that all cables are connected to the appropriate connectors. Some connectors have a similar appearance and may be easily confused (for example, do not plug a telephone cable into the network connector).
- Do not place your equipment in a closed-in wall unit or on a bed, sofa, or rug.
- Keep your device away from radiators and heat sources.
- Keep your equipment away from extremely hot or cold temperatures to ensure that it is used within the specified operating range.
- Do not push any objects into the air vents or openings of your equipment. Doing so can cause fire or electric shock by shorting out interior components.
- Avoid placing loose papers underneath your device. Do not place your device in a closed-in wall unit, or on a soft, fabric surface such as a bed, sofa, carpet, or a rug.

When operating your equipment:

- Do not use your equipment in a wet environment, for example, near a bath tub, sink, or swimming pool or in a wet basement.
- Do not use AC powered equipment during an electrical storm. Battery powered devices may be used

if all cables have been disconnected.

- Do not spill food or liquids on your equipment.
- Before you clean your equipment, disconnect it from the electrical outlet. Clean your device with a soft cloth dampened with water. Do not use liquids or aerosol cleaners, which may contain flammable substances.
- Clean the monitor display with a soft, clean cloth and water. Apply the water to the cloth, then stroke the cloth across the display in one direction, moving from the top of the display to the bottom. Remove moisture from the display quickly and keep the display dry.
- Long-term exposure to moisture can damage the display. Do not use a commercial window cleaner to clean your display.
- If your equipment does not operate normally - in particular, if there are any unusual sounds or smells coming from it - unplug it immediately and contact an authorized dealer or service center.

Protecting Against Electrostatic Discharge

Electrostatic discharge (ESD) events can harm electronic components inside your equipment. Under certain conditions, ESD may build up on your body or an object, such as a peripheral, and then discharge into another object, such as your computer. To prevent ESD damage, you should discharge static electricity from your body before you interact with any of your equipment's internal electronic components, such as a memory module. You can protect against ESD by touching a metal grounded object (such as an unpainted metal surface on your computer's I/O panel) before you interact with anything electronic. When connecting a peripheral (including handheld digital assistants) to your equipment, you should always ground both yourself and the peripheral before connecting it. In addition, as you work inside the equipment, periodically discharge any static charge your body may have accumulated.

You can also take the following steps to prevent damage from electrostatic discharge:

- When unpacking a static-sensitive component from its shipping carton, do not remove the component from the antistatic packing material until you are ready to install the component.
- Just before unwrapping the antistatic package, be sure to discharge static electricity from your body.
- When transporting a sensitive component, first place it in an antistatic container or packaging.
- Handle all electrostatic sensitive components in a static-safe area. If possible, use antistatic floor pads and work bench pads.

1.2 SAFETY: General Power Safety

Observe the following guidelines when connecting your equipment to a power source:

- Check the voltage rating before you connect the equipment to an electrical outlet to ensure that the required voltage and frequency match the available power source.
- Do not plug the equipment power cables into an electrical outlet if the power cable is damaged
- Norway and Sweden: If this product is provided with a 3-prong power cable, connect the power cable to a grounded electrical outlet only.
- If you use an extension power cable, ensure that the total ampere rating of the products plugged in to the extension power cable does not exceed the ampere rating of the extension cable.
- If you must use an extension cable or power strip, ensure the extension cable or power strip is connected to a wall power outlet and not to another extension cable or power strip. The extension cable or power strip must be designed for grounded plugs and plugged into a grounded wall outlet.
- If you are using a multiple-outlet power strip, use caution when plugging the power cable into the power strip. Some power strips may allow you to insert a plug incorrectly. Incorrect insertion of the power plug could result in permanent damage to your equipment, as well as risk of electric shock and/or fire. Ensure that the ground prong of the power plug is inserted into the mating ground contact of the power strip.
- Be sure to grasp the plug, not the cable, when disconnecting equipment from an electric socket.

If your equipment uses an AC adapter:

- Use only the Dell provided AC adapter approved for use with this device. Use of another AC adapter may cause a fire or explosion.
- NOTE: Refer to your system rating label for information on the proper adapter model approved for use with your device.
- Place the AC adapter in a ventilated area, such as a desk top or on the floor, when you use it to run the computer or to charge the battery. Do not cover the AC adapter with papers or other items that will reduce cooling; also, do not use the AC adapter inside a carrying case.
- The AC adapter may become hot during normal operation of your computer. Use care when handling the adapter during or immediately after operation.
- It is recommended that you lay the adapter on the floor or desk so that the green light is visible. This will alert you if the adapter should accidentally go off due to external effects. If for any reason the green light goes off, disconnect the AC power cord from the wall for a period of ten seconds, and then reconnect the power cord.
- Japan Only: Use only the Dell-provided AC power cable with the AC adapter. Use of any other power cable may damage the device or AC adapter or may present risk of fire or electric shock.

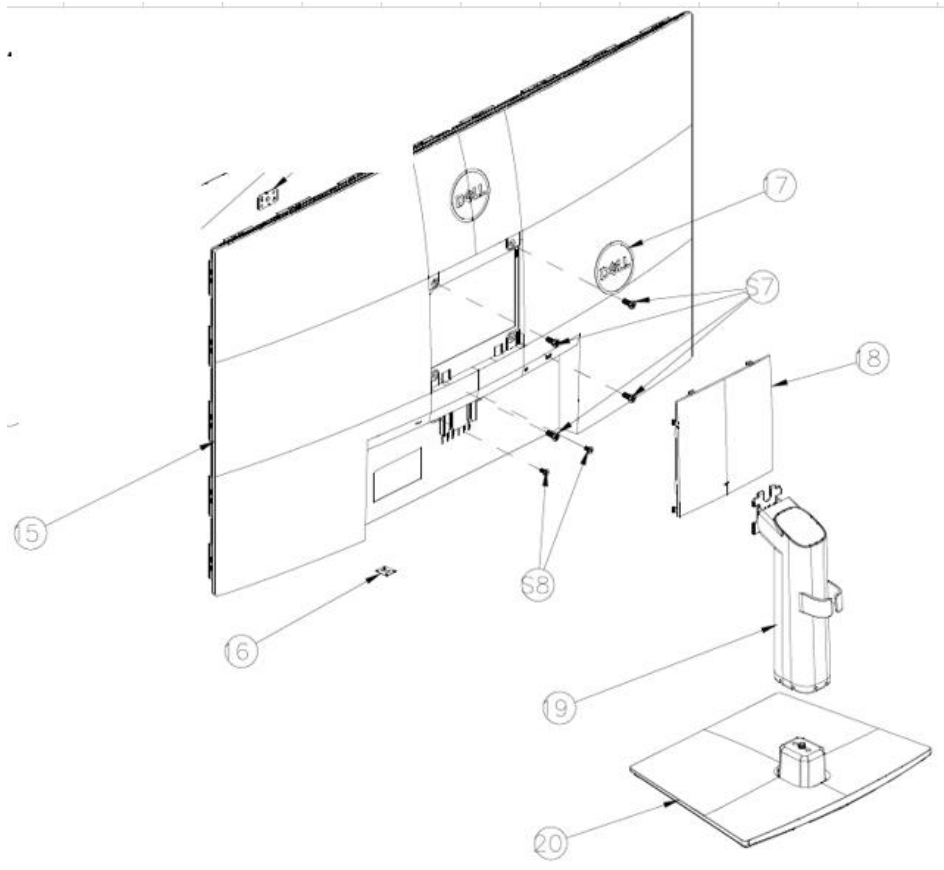

No.	Description	Q'ty	Remark
1	BEZEL	1	For EMEA Only, not for other regions
2	KEY BOARD	1	
3	KEY POWER	1	
4	KEY FUNCTION	1	
5	DELL LOGO	1	
7	SPONGE	1	
8	PANEL	1	
9	MYLAR	1	
10	POWER BOARD	1	
11	MAIN BOARD	1	
12	MAINFRAME	1	
13	STAND BUTTON	1	
14	VESA-RRACKET	2	
15	REAR COVER	1	
16	PLATE	1	
17	DELL LOGO	1	
18	COVER VESA	1	
19	HINGE ASS'Y	1	
20	BASE ASS'Y	1	
S1	SCREW -KEY	3	
S2	SCREW POWERBOARD	2	
S3	SCREW MAINBOARD	2	
S4	SCREW AC	1	
S5	SCREW PANEL	2	
S6	SCREW BUTTON	1	
S7	SCREW VESA	4	
S8	SCREW REAR COVER	2	
21	Power Cable	1	See "NOTE"
22	HDMI 1.4	1	See "NOTE"
23	VGA CABLE	1	See "NOTE"

NOTE:

For replacement of power cord, connectivity cable and external power supply (if applicable), contact Dell:

1. Go to <https://www.dell.com/support>.
2. Verify your country or region in the Choose A Country/Region drop-down menu at the bottom-right corner of the page.
3. Click Contact Us next to the country dropdown.
4. Select the appropriate service or support link based on your need.
5. Choose the method of contacting Dell that is convenient for you

3. Wiring connectivity diagram

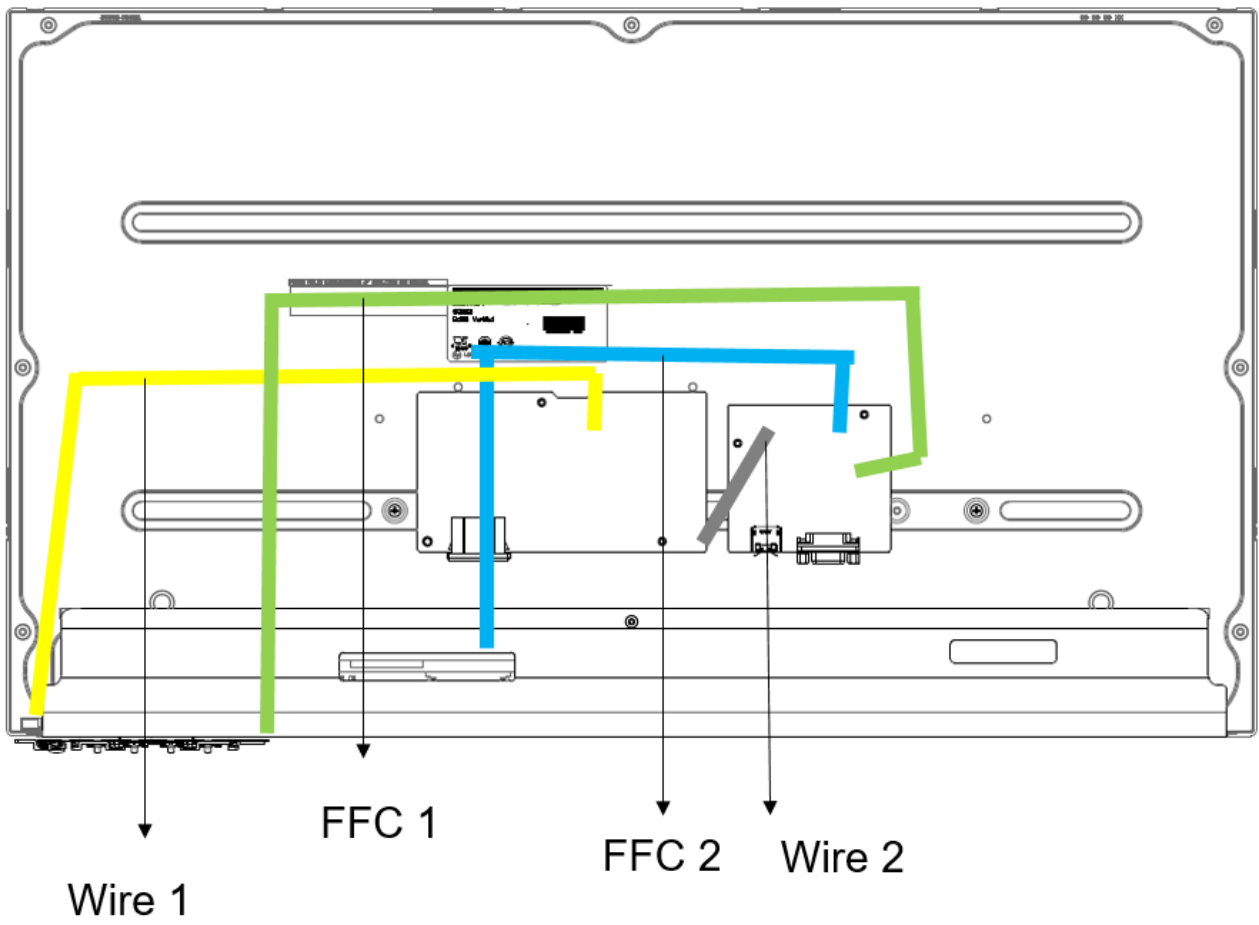

4. How to connect and disconnect power cable/ connectivity cable

⚠ WARNING: Before you begin any of the procedures in this section, follow the [Safety instructions](#).

✎ NOTE: Do not connect all cables to the monitor at the same time. It is recommended to route the cables through the cable-management clip before you connect them to the monitor.

To connect your monitor to the computer:

1. Turn off your computer and disconnect the power cable.
2. Connect the VGA cable or HDMI cable from your monitor to the computer.

Connecting the VGA/HDMI Cable

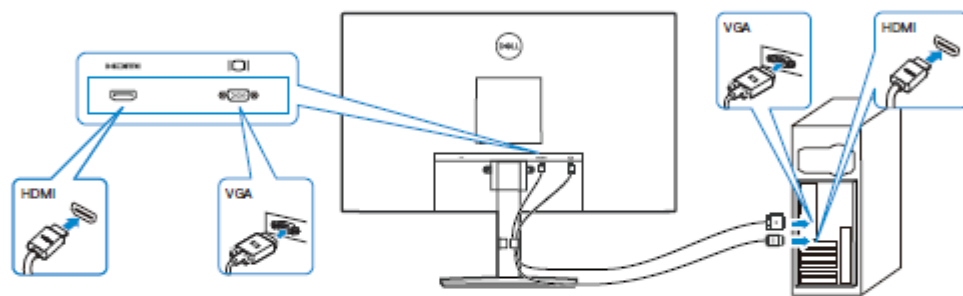

3. Connect the power cables from your computer and monitor into a wall outlet.

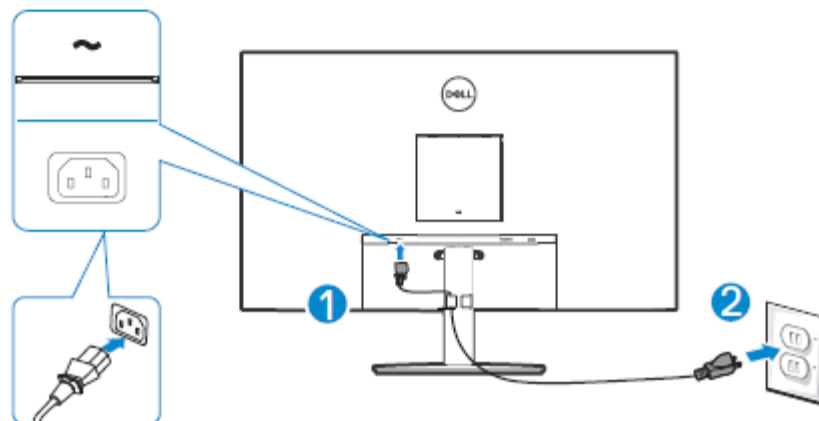

5. Mechanical Instruction

NOTE:

This “Disassembly and Assembly Procedures” is for EMEA only, not for other regions. Please note that Dell will deem warranty void if any disassembly is done on the monitors.

Tools Required

List the type and size of the tools that would typically can be used to disassemble the product to a point where components and materials requiring selective treatment can be removed.

Tool Description:

- Screwdriver (Phillip-head, Hexagonal head)
- Penknife

5.1 Disassembly Procedures

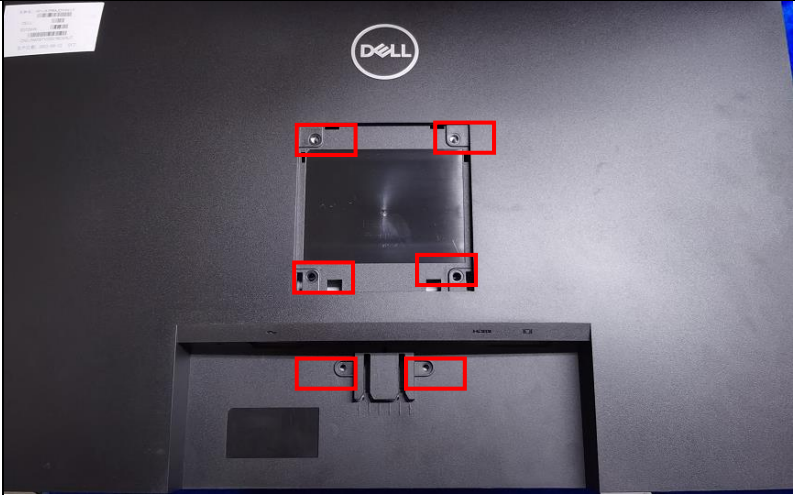
Step	Figure	Remark
Remove Stand ass'y	 A photograph showing the rear of a Dell monitor. The monitor is mounted on a stand. A rectangular metal plate, which is the stand assembly, is being pulled upwards from the back of the monitor. The Dell logo is visible at the top center of the monitor's back panel. The background is a blue protective cloth.	Pull up the stand ass'y
Remove the rear cover	 A photograph showing the rear of a Dell monitor. Six screws are highlighted with red rectangular boxes. Two screws are on the top edge of the monitor's back panel, two are on the bottom edge, and two are on the bottom edge of the stand assembly. The Dell logo is visible at the top center of the monitor's back panel.	Remove the 6 pcs screws .

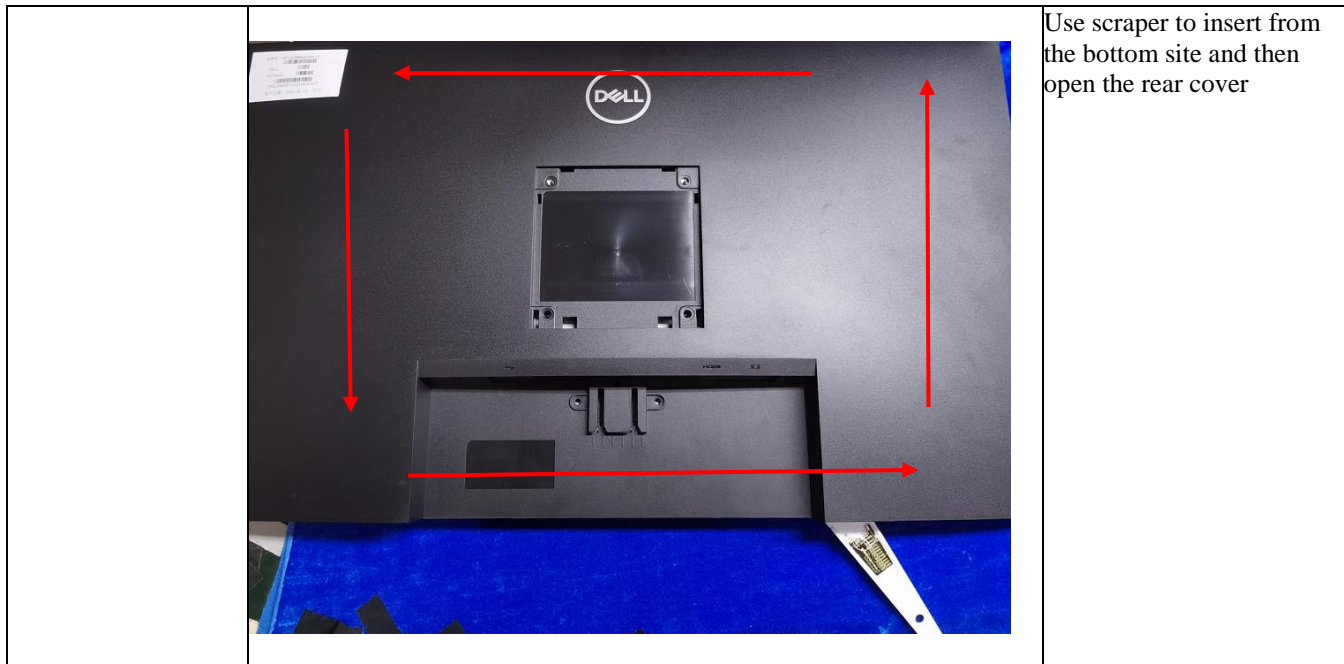

Use scraper to insert from the bottom site and then open the rear cover

Remove the mainframe

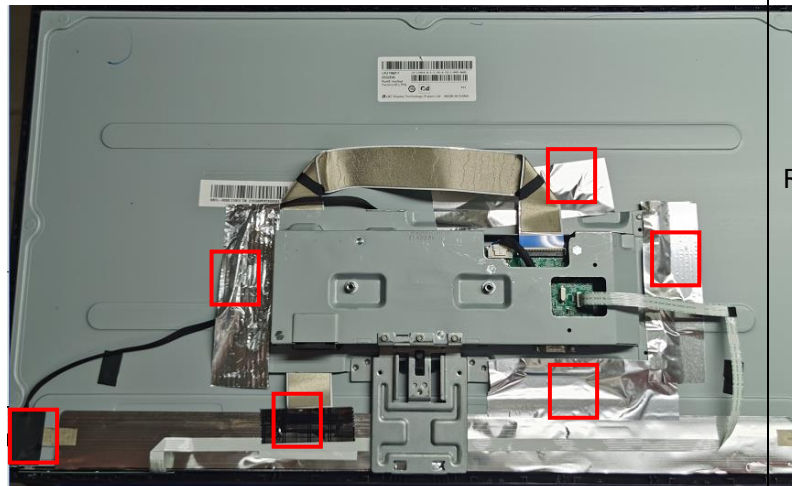

Remove the tapes

Remove maylar

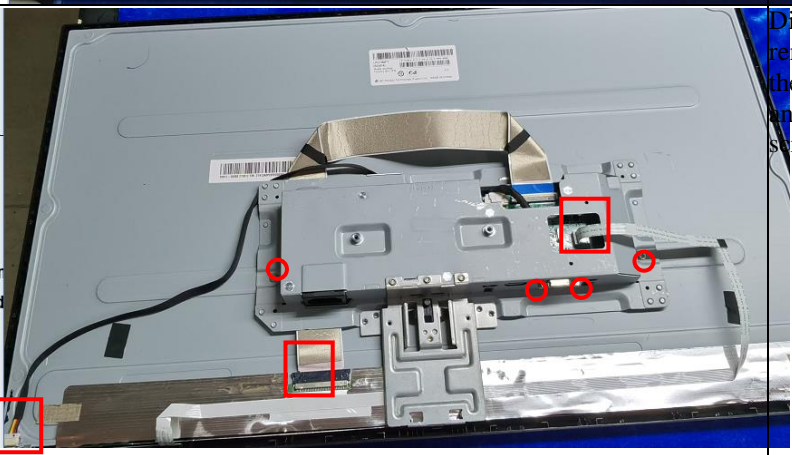

Disconnect the cables and remove the 2 pcs screws on the site of the mainframe and 2 pcs of hexagon screws

Remove maylar



Remove the powerbard and mainboard

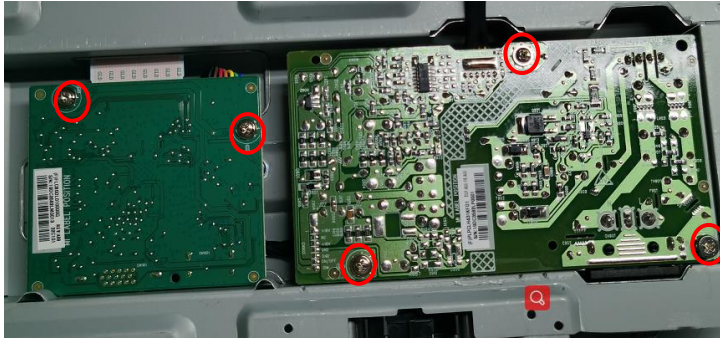

Remove the screws on the mainboard and power board

Mainboard and powerboard



5.2 Assembly Procedures

Assemble the powerbard and mainboard

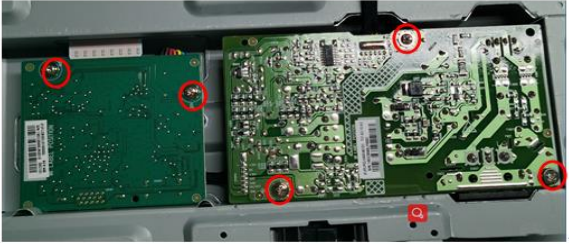

Tighten the screws on the boards

Assemble maylar

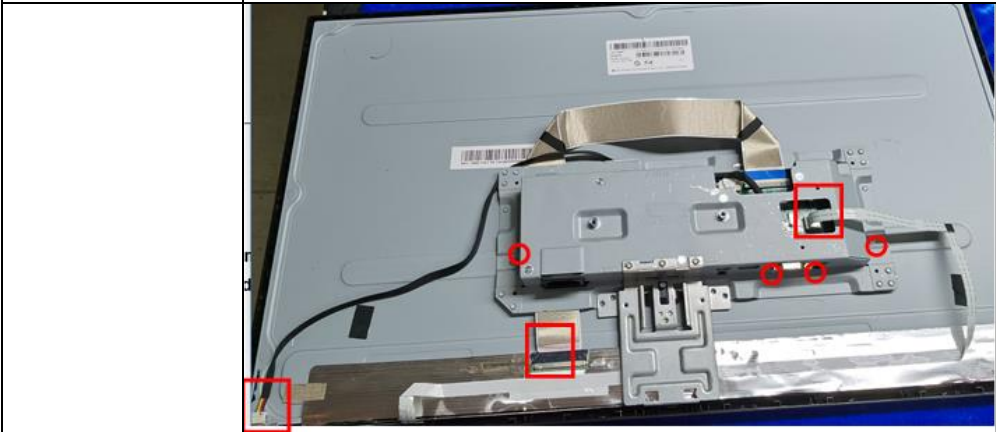

connect the cables and tighten the 2 pcs screws on the site of the mainframe and 2 pcs of hexagon screws

assemble the mainframe

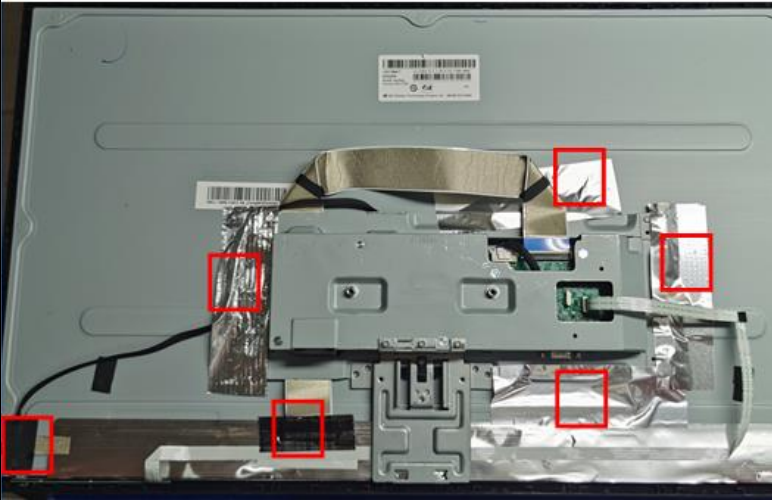

Re-stick the tapes

Assemble the rear cover

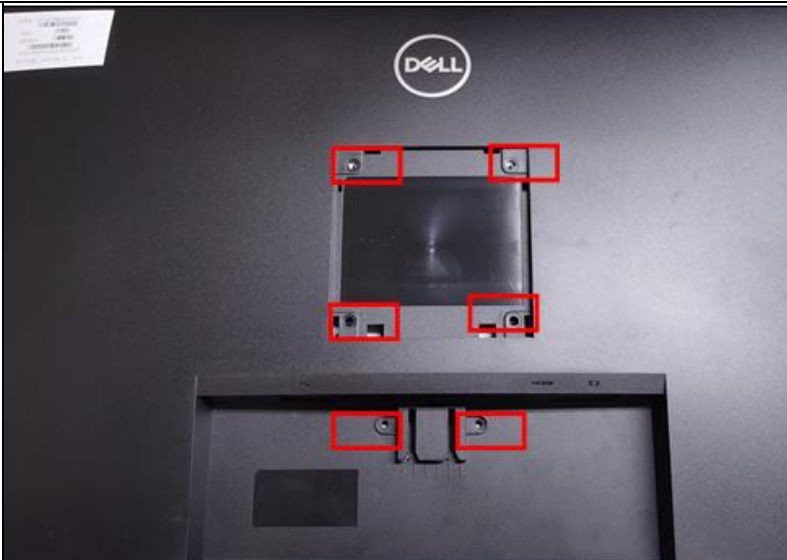

tighten the 6 pcs screws .

Assemble the stand ass'y



Pull in the stand ass'y

6. Trouble shooting instructions

 **WARNING:** Before you begin any of the procedures in this section, follow the [Safety instructions](#).

Self-Test

Your monitor provides a self-test feature that allows you to check if your monitor is functioning properly. If your monitor and computer are properly connected but the monitor screen remains dark, run the monitor self-test by performing the following steps:

1. Turn off both your computer and the monitor.
2. Disconnect all video cables from the monitor. This way, the computer doesn't have to be involved.
3. Turn on the monitor.

If the monitor is working correctly, it detects that there is no signal and one of the following message appears. While in self-test mode, the power LED remains white.

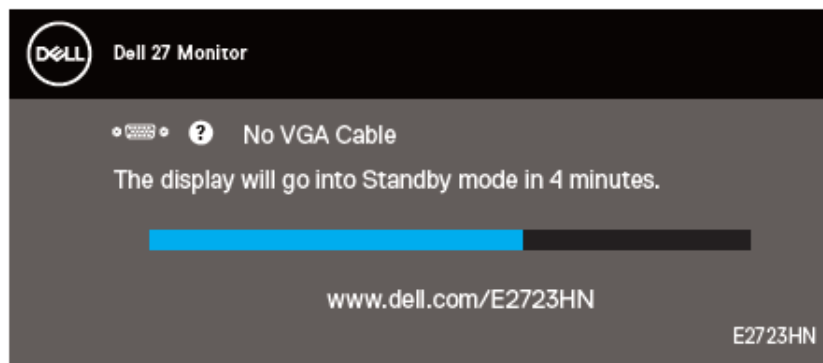

or

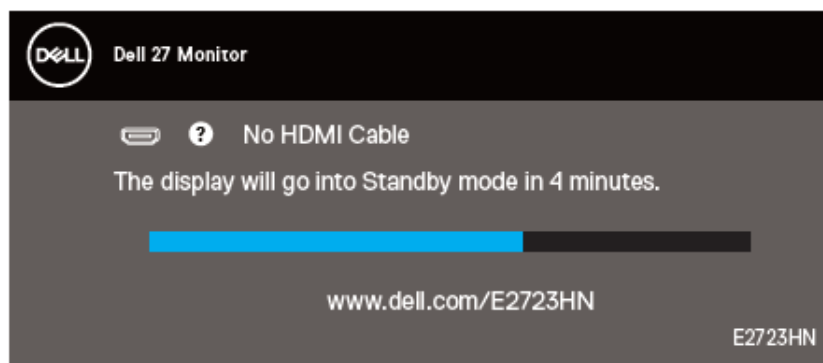

 **NOTE:** This box also appears during normal system operation, if the video cable is disconnected or damaged.

4. Turn Off your monitor and reconnect the video cable; then turn on your computer and the monitor.

If your monitor remains dark after you reconnect the cables, check your video controller and computer.

 **NOTE:** Monitor damages due to improper cleaning methods and the use of benzene, thinner, ammonia, abrasive cleaners, alcohol, compressed air, detergent of any kind will lead to a Customer Induced Damage (CID). **CID is not covered under the standard Dell warranty.**

- If you notice white powder when you unpack your monitor, wipe it off with a cloth.
- Handle your monitor with care as the black-colored monitor may get scratched and show white scuff marks.
- To help maintain the best image quality on your monitor, use a dynamically changing screen saver and turn off your monitor when not in use.

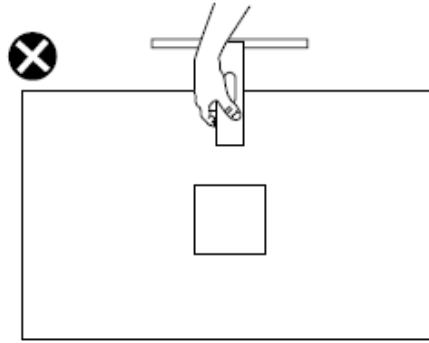

Maintenance guidelines

Cleaning your monitor

⚠ WARNING: Before cleaning the monitor, unplug the monitor power cable from the electrical outlet.

⚠ CAUTION: Read and follow the [Safety instructions](#) before cleaning the monitor.

Improper cleaning methods can result in physical damage to Dell monitors. Physical defects may affect the screen and body of the monitor.

For best practices, follow the instructions in the list below while unpacking, cleaning or handling your monitor:

- To clean the Dell Monitor screen, lightly dampen a soft, clean cloth with water. If possible, use a special screen-cleaning tissue or solution suitable for the Dell Monitor screen.

⚠ CAUTION: Do not use detergents of any kind or other chemicals such as benzene, thinner, ammonia, abrasive cleaners, alcohol, or compressed air.

- **Do not directly spray the cleaning solution or even water on the surface of the monitor.** Directly spraying liquid onto the panel will roll down to the bottom of the panel and corrode the electronics resulting in permanent damage. Instead, apply solution or water to soft cloth material.

✎ NOTE: Using cleaner may cause changes in the appearance of the monitor, such as color fading, milky film on the monitor, deformation, uneven dark shade, and screen surface peeling.

Built-in diagnostics

Your monitor has a built-in diagnostic tool that helps you determine if any screen abnormality you experience is an inherent problem with your monitor, or with your computer and video card.

 **NOTE: You can run the built-in diagnostics only when the video cable is unplugged and the monitor is in self-test mode.**

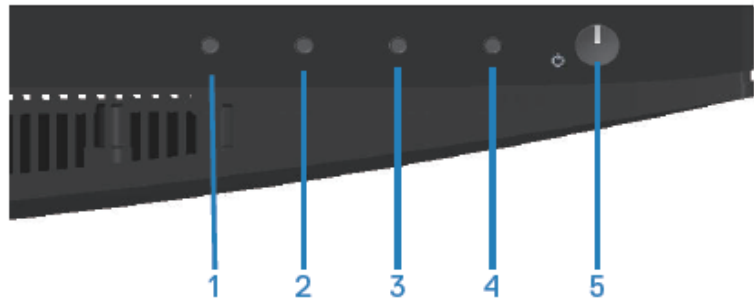

To run the built-in diagnostics:

1. Ensure that the screen is clean (no dust particles on the surface of the screen).
2. Unplug the video cable(s) from the back of the computer or monitor. The monitor then goes into the self-test mode.
3. Press and hold the Exit button (button 4) for four seconds to enter the OSD lock/unlock menu.

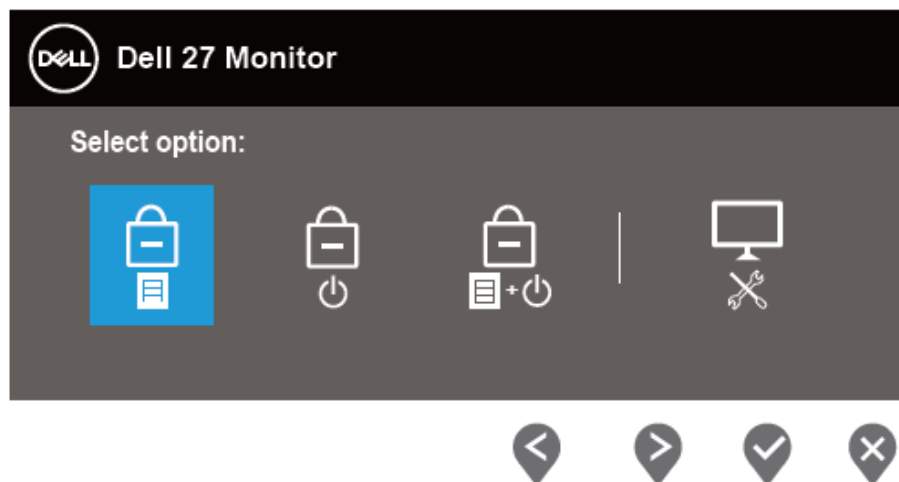

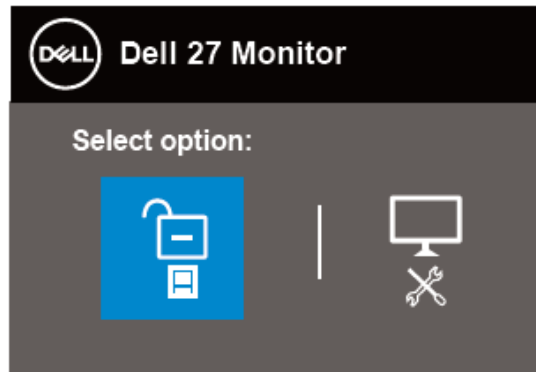

4. Select the  icon to run the built-in diagnostics.
5. Carefully inspect the screen for abnormalities.
6. Press the Up button (button 1) on the back cover again. The color of the screen changes to grey.
7. Inspect the display for any abnormalities.
8. Repeat step 6 and 7 to inspect the display in red, green, blue, black, white and text pattern screens.

The test is complete when the text pattern screen appears. To exit, press the Up button (button 1) again.

If you do not detect any screen abnormalities upon using the built-in diagnostic tool, the monitor is functioning properly. Check the video card and computer.

Common problems

The following table contains general information about common monitor problems you might encounter and the possible solutions:

Common Symptoms	Possible Solutions
No Video/Power LED off	<ul style="list-style-type: none">Ensure that the video cable connecting the monitor and the computer is properly connected and secure.Verify that the power outlet is functioning properly using any other electrical equipment.Ensure that the power button is pressed.Ensure that the correct input source is selected via the Input Source menu.
No Video/Power LED on	<ul style="list-style-type: none">Increase brightness and contrast controls using the OSD.Perform monitor self-test feature check.Check for bent or broken pins in the video cable connector.Run the built-in diagnostics.Ensure that the correct input source is selected via the Input Source menu.
Poor Focus	<ul style="list-style-type: none">Eliminate video extension cables.Reset the monitor to Factory Settings (Factory Reset).Change the video resolution to the correct aspect ratio.
Shaky/Jittery Video	<ul style="list-style-type: none">Reset the monitor to Factory Settings (Factory Reset).Check environmental factors.Relocate the monitor and test in another room.
Missing Pixels	<ul style="list-style-type: none">Cycle power On-Off.Pixel that is permanently Off is a natural defect that can occur in LCD technology.For more information on Dell Monitor Quality and Pixel Policy, see Dell Support site at: www.dell.com/pixelguidelines.

Stuck-on Pixels	<ul style="list-style-type: none"> • Cycle power On-Off. • Pixel that is permanently off is a natural defect that can occur in LCD technology. • For more information on Dell Monitor Quality and Pixel Policy, see Dell Support site at: www.dell.com/pixelguidelines.
Brightness Problems	<ul style="list-style-type: none"> • Reset the monitor to Factory Settings (Factory Reset). • Adjust brightness & contrast controls via OSD.
Geometric Distortion	<ul style="list-style-type: none"> • Reset the monitor to Factory Settings (Factory Reset). • Adjust horizontal & vertical controls via OSD.
Horizontal/Vertical Lines	<ul style="list-style-type: none"> • Reset the monitor to Factory Settings (Factory Reset). • Perform monitor self-test feature check and determine if these lines are also in self-test mode. • Check for bent or broken pins in the video cable connector. • Run the built-in diagnostics.
Synchronization Problems	<ul style="list-style-type: none"> • Reset the monitor to Factory Settings (Factory Reset). • Perform monitor self-test feature check to determine if the scrambled screen appears in self-test mode. • Check for bent or broken pins in the video cable connector. • Restart the computer in the safe mode.
Safety Related Issues	<ul style="list-style-type: none"> • Do not perform any troubleshooting steps. • Contact Dell immediately.
Intermittent Problems	<ul style="list-style-type: none"> • Ensure that the video cable connecting the monitor to the computer is connected properly and is secure. • Reset the monitor to Factory Settings (Factory Reset). • Perform monitor self-test feature check to determine if the intermittent problem occurs in self-test mode.
Missing Color	<ul style="list-style-type: none"> • Perform monitor self-test feature check. • Ensure that the video cable connecting the monitor to the computer is connected properly and is secure. • Check for bent or broken pins in the video cable connector.

Wrong Color	<ul style="list-style-type: none"> • Try different Preset Modes in Color settings OSD. Adjust R/G/B value in Custom Color in Color settings OSD. • Change the Input Color Format to RGB or YCbCr/YPbPr in the Color settings OSD. • Run the built-in diagnostics.
Image retention from a static image left on the monitor for a long period of time	<ul style="list-style-type: none"> • Set the screen to turn off after a few minutes of screen idle time. These can be adjusted in Windows Power Options or Mac Energy Saver setting. • Alternatively, use a dynamically changing screensaver.
Video Ghosting or Overshooting	<ul style="list-style-type: none"> • Change the Response Time in the Display OSD to Normal or Fast depending on your application and usage.

