

ASUS®

**PA32UCR Series
LCD Monitor**

User Guide

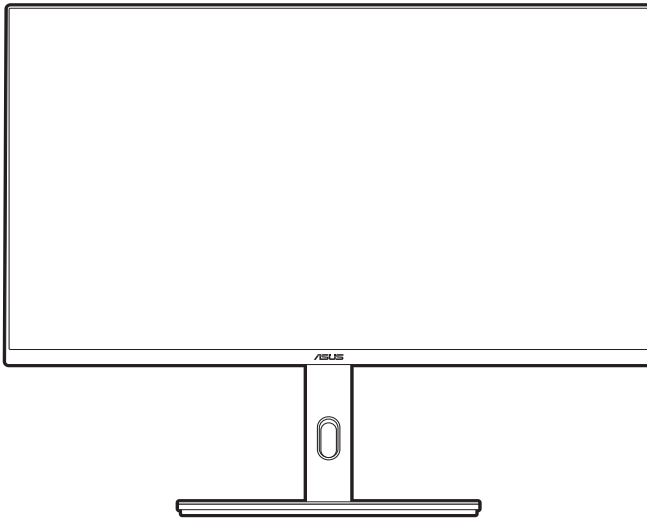

HDMI™
HIGH-DEFINITION MULTIMEDIA INTERFACE

First Edition

October 2021

Copyright © 2021 ASUSTeK COMPUTER INC. All Rights Reserved.

No part of this manual, including the products and software described in it, may be reproduced, transmitted, transcribed, stored in a retrieval system, or translated into any language in any form or by any means, except documentation kept by the purchaser for backup purposes, without the express written permission of ASUSTeK COMPUTER INC. ("ASUS").

Product warranty or service will not be extended if: (1) the product is repaired, modified or altered, unless such repair, modification or alteration is authorized in writing by ASUS; or (2) the serial number of the product is defaced or missing.

ASUS PROVIDES THIS MANUAL "AS IS" WITHOUT WARRANTY OF ANY KIND, EITHER EXPRESS OR IMPLIED, INCLUDING BUT NOT LIMITED TO THE IMPLIED WARRANTIES OR CONDITIONS OF MERCHANTABILITY OR FITNESS FOR A PARTICULAR PURPOSE. IN NO EVENT SHALL ASUS, ITS DIRECTORS, OFFICERS, EMPLOYEES OR AGENTS BE LIABLE FOR ANY INDIRECT, SPECIAL, INCIDENTAL, OR CONSEQUENTIAL DAMAGES (INCLUDING DAMAGES FOR LOSS OF PROFITS, LOSS OF BUSINESS, LOSS OF USE OR DATA, INTERRUPTION OF BUSINESS AND THE LIKE), EVEN IF ASUS HAS BEEN ADVISED OF THE POSSIBILITY OF SUCH DAMAGES ARISING FROM ANY DEFECT OR ERROR IN THIS MANUAL OR PRODUCT.

SPECIFICATIONS AND INFORMATION CONTAINED IN THIS MANUAL ARE FURNISHED FOR INFORMATIONAL USE ONLY, AND ARE SUBJECT TO CHANGE AT ANY TIME WITHOUT NOTICE, AND SHOULD NOT BE CONSTRUED AS A COMMITMENT BY ASUS. ASUS ASSUMES NO RESPONSIBILITY OR LIABILITY FOR ANY ERRORS OR INACCURACIES THAT MAY APPEAR IN THIS MANUAL, INCLUDING THE PRODUCTS AND SOFTWARE DESCRIBED IN IT.

Products and corporate names appearing in this manual may or may not be registered trademarks or copyrights of their respective companies, and are used only for identification or explanation and to the owners' benefit, without intent to infringe.

Contents

Contents	iii
Notices.....	iv
Safety information	vi
Care & Cleaning.....	vii
Takeback Services.....	viii
Product information for EU energy label.....	viii
Chapter 1: Product introduction	
1.1 Welcome!	1-1
1.2 Package contents.....	1-1
1.3 Monitor introduction.....	1-2
1.3.1 Front view	1-2
1.3.2 Back view.....	1-3
1.3.3 Other Function(s)	1-4
Chapter 2: Setup	
2.1 Attaching the arm/base	2-1
2.2 Detaching the arm/base (for VESA wall mount).....	2-1
2.3 Adjusting the monitor.....	2-2
2.4 Connecting the cables.....	2-4
2.5 Turning on the monitor.....	2-5
Chapter 3: General instructions	
3.1 OSD (On-Screen Display) menu	3-1
3.1.1 How to reconfigure.....	3-1
3.1.2 OSD function introduction.....	3-2
3.2 Specifications summary.....	3-13
3.3 Outline dimensions.....	3-15
3.4 Troubleshooting (FAQ).....	3-16
3.5 Supported operating modes	3-17

Notices

Federal Communications Commission Statement

This device complies with Part 15 of the FCC Rules. Operation is subject to the following two conditions:

- This device may not cause harmful interference, and
- This device must accept any interference received including interference that may cause undesired operation.

This equipment has been tested and found to comply with the limits for a Class B digital device, pursuant to Part 15 of the FCC Rules. These limits are designed to provide reasonable protection against harmful interference in a residential installation. This equipment generates, uses and can radiate radio frequency energy and, if not installed and used in accordance with the instructions, may cause harmful interference to radio communications. However, there is no guarantee that interference will not occur in a particular installation. If this equipment does cause harmful interference to radio or television reception, which can be determined by turning the equipment off and on, the user is encouraged to try to correct the interference by one or more of the following measures:

- Reorient or relocate the receiving antenna.
- Increase the separation between the equipment and receiver.
- Connect the equipment into an outlet on a circuit different from that to which the receiver is connected.
- Consult the dealer or an experienced radio/TV technician for help.



The use of shielded cables for connection of the monitor to the graphics card is required to assure compliance with FCC regulations. Changes or modifications to this unit not expressly approved by the party responsible for compliance could void the user's authority to operate this equipment.

ENERGY STAR complied product



ENERGY STAR is a joint program of the U.S. Environmental Protection Agency and the U.S. Department of Energy helping us all save money and protect the environment through energy efficient products and practices.

All ASUS products with the ENERGY STAR logo comply with the ENERGY STAR standard, and the power management feature is enabled by default. The monitor and computer are automatically set to sleep after 10 and 30 minutes of user inactivity. To wake your computer, click the mouse or press any key on the keyboard. Please visit <http://www.energystar.gov/powermanagement> for detail information on power management and its benefits to the environment. In addition, please visit <http://www.energystar.gov> for detail information on the ENERGY STAR joint program.



NOTE: Energy Star is NOT supported on FreeDOS and Linux-based operating system.

Canadian Department of Communications Statement

This digital apparatus does not exceed the Class B limits for radio noise emissions from digital apparatus set out in the Radio Interference Regulations of the Canadian Department of Communications.

This class B digital apparatus complies with Canadian ICES-003.

This Class B digital apparatus meets all requirements of the Canadian Interference - Causing Equipment Regulations.

Cet appareil numérique de la classe B respecte toutes les exigences du Règlement sur le matériel brouiller du Canada.



Safety information

- Before setting up the monitor, carefully read all the documentation that came with the package.
- To prevent fire or shock hazard, never expose the monitor to rain or moisture.
- Never try to open the monitor cabinet. The dangerous high voltages inside the monitor may result in serious physical injury.
- If the power supply is broken, do not try to fix it by yourself. Contact a qualified service technician or your retailer.
- Before using the product, make sure all cables are correctly connected and the power cables are not damaged. If you detect any damage, contact your dealer immediately.
- Slots and openings on the back or top of the cabinet are provided for ventilation. Do not block these slots. Never place this product near or over a radiator or heat source unless proper ventilation is provided.
- The monitor should be operated only from the type of power source indicated on the label. If you are not sure of the type of power supply to your home, consult your dealer or local power company.
- Use the appropriate power plug which complies with your local power standard.
- Do not overload power strips and extension cords. Overloading can result in fire or electric shock.
- Avoid dust, humidity, and temperature extremes. Do not place the monitor in any area where it may become wet. Place the monitor on a stable surface.
- Unplug the unit during a lightning storm or if it will not be used for a long period of time. This will protect the monitor from damage due to power surges.
- Never push objects or spill liquid of any kind into the slots on the monitor cabinet.
- To ensure satisfactory operation, use the monitor only with UL listed computers which have appropriate configured receptacles marked between 100-240V AC.
- If you encounter technical problems with the monitor, contact a qualified service technician or your retailer.
- Adjustment of the volume control as well as the equalizer to other settings than the center position may increase the ear-/headphones output voltage and therefore the sound pressure level.



This symbol of the crossed out wheeled bin indicates that the product (electrical, electronic equipment, and mercury-containing button cell battery) should not be placed in municipal waste. Please check local regulations for disposal of electronic products.

AEEE yönetmeliğine uygundur

Care & Cleaning

- Before you lift or reposition your monitor, it is better to disconnect the cables and power cord. Follow the correct lifting techniques when positioning the monitor. When lifting or carrying the monitor, grasp the edges of the monitor. Do not lift the display by the stand or the cord.
- Cleaning. Turn your monitor off and unplug the power cord. Clean the monitor surface with a lint-free, non-abrasive cloth. Stubborn stains may be removed with a cloth dampened with mild cleaner.
- Avoid using a cleaner containing alcohol or acetone. Use a cleaner intended for use with the monitor. Never spray cleaner directly on the screen, as it may drip inside the monitor and cause an electric shock.

The following symptoms are normal with the monitor:

- You may find slightly uneven brightness on the screen depending on the desktop pattern you use.
- When the same image is displayed for hours, an afterimage of the previous screen may remain after switching the image. The screen will recover slowly or you can turn off the Power Switch for hours.
- When the screen becomes black or flashes, or cannot work anymore, contact your dealer or service center to fix it. Do not repair the screen by yourself!

Conventions used in this guide



WARNING: Information to prevent injury to yourself when trying to complete a task.



CAUTION: Information to prevent damage to the components when trying to complete a task.



IMPORTANT: Information that you **MUST** follow to complete a task.



NOTE: Tips and additional information to aid in completing a task.

Where to find more information

Refer to the following sources for additional information and for product and software updates.

1. ASUS websites

The ASUS websites worldwide provide updated information on ASUS hardware and software products. Refer to <http://www.asus.com>

2. Optional documentation

Your product package may include optional documentation that may have been added by your dealer. These documents are not part of the standard package.

Takeback Services

ASUS recycling and takeback programs come from our commitment to the highest standards for protecting our environment. We believe in providing solutions for our customers to be able to responsibly recycle our products, batteries and other components as well as the packaging materials.

Please go to <http://csr.asus.com/english/Takeback.htm> for detail recycling information in different region.

Product information for EU energy label



PA32UCR



PA32UCR-K

1.1 Welcome!

Thank you for purchasing the ASUS® LCD monitor!

The latest widescreen LCD monitor from ASUS provides a broader, brighter and crystal-clear display, plus a host of features that enhance your viewing experience.

With these features, you can enjoy the convenience and delightful visual experience that the monitor brings to you!

1.2 Package contents

Check your package for the following items:

- ✓ LCD monitor
- ✓ Monitor base
- ✓ Quick start guide
- ✓ Warranty card
- ✓ Power cord
- ✓ HDMI cable (optional)
- ✓ USB Type C cable
- ✓ DisplayPort cable (optional)
- ✓ Color Calibration Testing Report
- ✓ Input/Output port cover
- ✓ ProArt welcome card
- ✓ Color Calibrator (for PA32UCR-K only)



If any of the above items is damaged or missing, contact your retailer immediately.

1.3 Monitor introduction

1.3.1 Front view

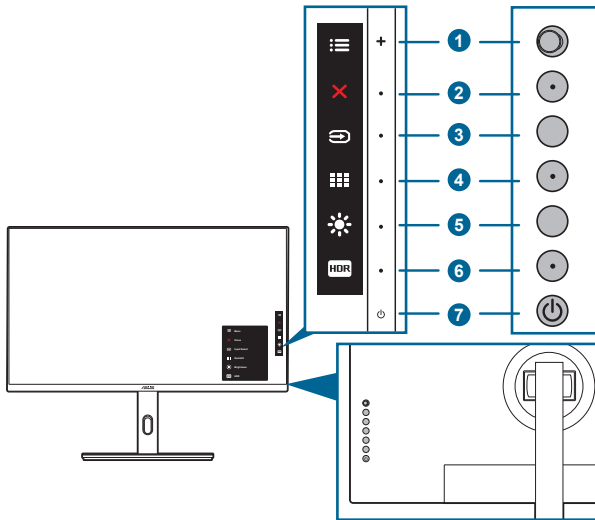

- ☰** Menu (5-way) button:
 - Press this button to enter the OSD menu.
 - Enacts the selected OSD menu items.
 - Increases/Decreases values or moves your selection up/down/left/right.
- ✕** Close button:
 - Exits the OSD menu.
 - Toggles the Key Lock function between on and off with a long press for 5 seconds.
- ↻** Input select button:
 - Selects an available input source.



Press **↻** button (Input Select button) to display HDMI-1, HDMI-2, HDMI-3, DisplayPort, USB Type-C signals after you connect HDMI/DisplayPort/USB Type-C cable with the monitor.

- ⏏** QuickFit Plus button:
 - This is a hotkey to open the QuickFit Plus menu.
- ☀** Shortcut **1**
 - Default: Brightness hotkey
 - To change the hotkey function, go to the Shortcut > Shortcut 1 menu.

6. Shortcut 2

- Default: HDR hotkey
- To change the hotkey function, go to the Shortcut > Shortcut 2 menu.

7. Power button/power indicator

- Turns the monitor on/off.
- The color definition of the power indicator is as the below table.

Status	Description
White	On
Amber	Standby mode
Off	Off

1.3.2 Back view

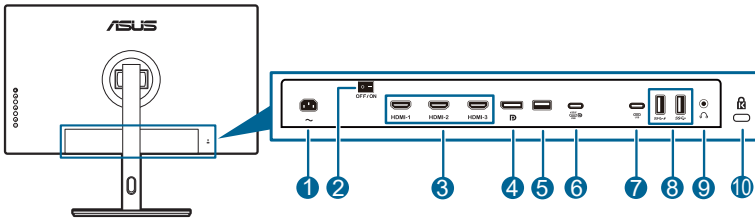

1. **AC-IN port.** This port connects the power cord.
2. **Power switch.** Press the switch to turn on/off power.
3. **HDMI ports.** These ports are for connection with an HDMI compatible device.
4. **DisplayPort in.** This port is for connection with a DisplayPort compatible device.



The default setting of DisplayPort Stream in the OSD menu is DisplayPort 1.2. You can change it to DisplayPort 1.1 when your device output signal is DisplayPort 1.1.

5. **USB 2.0 Type A.** This port is for service only.
6. **USB 3.1 Type-C** (supports DP Alt mode). This port is for connection with a DisplayPort/USB Type-C compatible device. This port is also for connection with a USB upstream cable, which supports USB power and data delivery.



This monitor is Super-Speed USB 3.1 compatible(5Gbps). The port offer 80W power delivery with output voltage of 5V/3A, 9V/3A, 12V/3A 15V/3A, 20V/4A.

7. **USB 3.1 Type-C.** This port is for connection with a USB downstream cable. The connection supports USB power and data delivery.



This monitor is Super-Speed USB 3.0 compatible (5Gbps).

- 8. USB 3.1 Type A:** These ports are for connection with USB devices, such as USB keyboard/mouse, USB flash drive, etc.



Port with *SS* icon is BC1.2 compliant (5V/1.5A).

- 9. Earphone jack.**

- 10. Kensington lock slot.**

1.3.3 Other Function(s)

1. HDR

The monitor supports HDR format. When detecting HDR content, an "HDR ON" message will pop up and display in the Information page.



HDR content is not supported when PIP/PBP mode is on.

2.1 Attaching the arm/base

To assemble the monitor base:

1. Have the front of the monitor face down on a table.
2. Remove the input/output port cover (Figure 1).
3. Attach the base into the arm, making sure the tab on the arm fits into the groove on the base (Figure 2).

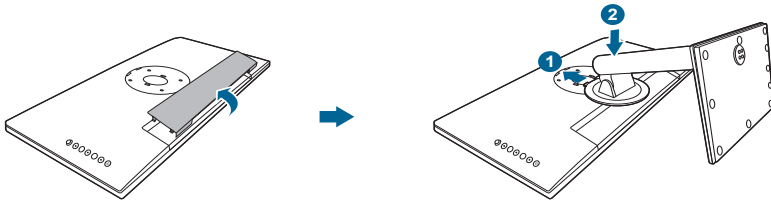

(Figure 1)

(Figure 2)



We recommend that you cover the table surface with soft cloth to prevent damage to the monitor.

2.2 Detaching the arm/base (for VESA wall mount)

The detachable arm/base of this monitor is specially designed for VESA wall mount.

To detach the arm/base:

1. Have the front of the monitor face down on a table.
2. Remove the input/output port cover (Figure 1).
3. Press the release button, and then detach the arm/base from the monitor (Figure 2).

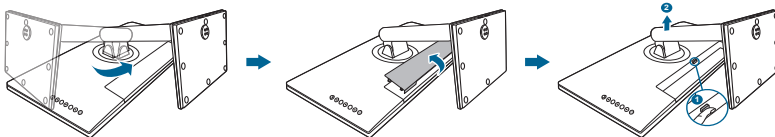

(Figure 1)

(Figure 2)



We recommend that you cover the table surface with soft cloth to prevent damage to the monitor.



- The VESA wall mount kit (100 x 100 mm) is purchased separately.
- Use only the UL Listed Wall Mount Bracket with minimum weight/load 22.7kg (Screw size: M4 x 10 mm).

2.3 Adjusting the monitor

- For optimal viewing, we recommend that you look at the full face of the monitor, then adjust the monitor to the angle that is most comfortable for you.
- Hold the stand to prevent the monitor from falling when you change its angle.
- You can adjust the monitor's angle from $+23^\circ$ to -5° , and it allows 30° swivel adjustment from either left or right. You can also adjust the monitor's height within ± 130 mm.

(Tilt)

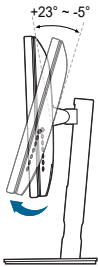

(Swivel)

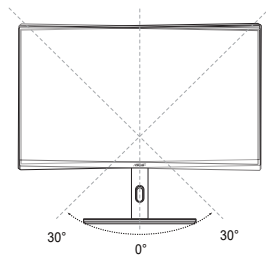

(Height adjustment)

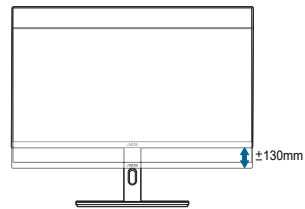

Pivoting the monitor

1. Lift the monitor to the highest position.
2. Tilt the monitor to its maximum angle.
3. Pivot the monitor to the angle you need.

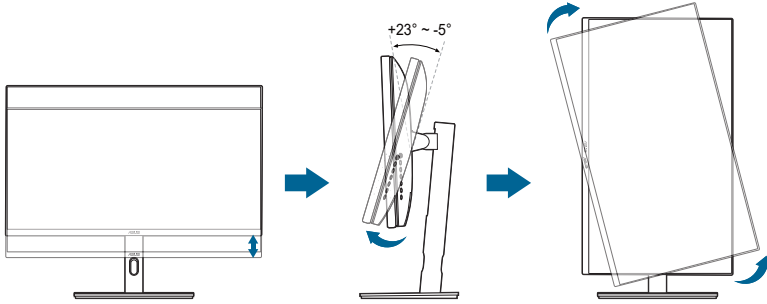

It is normal that the monitor slightly shakes while you adjust the viewing angle.

4. The OSD menu item will automatically rotate when the monitor rotates.

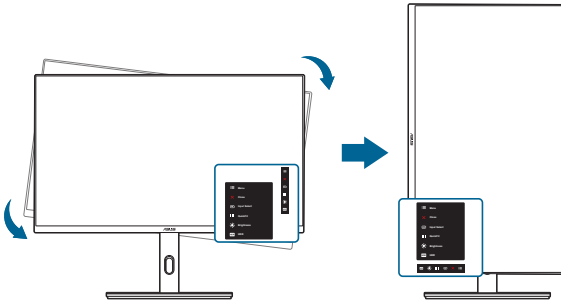

2.4 Connecting the cables

1. Connect the cables as the following instructions:

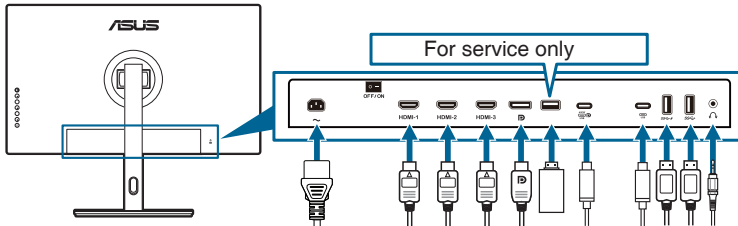

- **To connect the power cord:** Connect one end of the power cord securely to the monitor's AC input port, the other end to a power outlet.
- **To connect the HDMI/DisplayPort/USB Type-C cable:**
 - a. Plug one end of the HDMI/DisplayPort cable to the monitor's HDMI/DisplayPort/USB Type-C jack.
 - b. Connect the other end of the HDMI/DisplayPort/USB Type-C cable to your device's HDMI/DisplayPort/USB Type-C jack.
- **To use the earphone:** connect the end with plug type to the monitor's earphone jack when an HDMI/DisplayPort/USB Type-C signal is fed.
- **To use the USB 3.1 ports:**
 - » Upstream: Take the supplied USB 3.1 Type-C cable, and plug one end to the monitor's USB upstream port, and the other end to your computer's USB 3.1 port. Make sure your computer is installed with the latest Windows 7/Windows 10/Windows 11 operating system. That will enable the USB ports on the monitor to work.
 - » Downstream: Plug the USB Type A/Type-C cable of your device to the monitor's USB Type A/Type-C jack.



When these cables are connected, you can choose the desired signal from the Input Select item in the OSD menu.

2. Arranging the cables

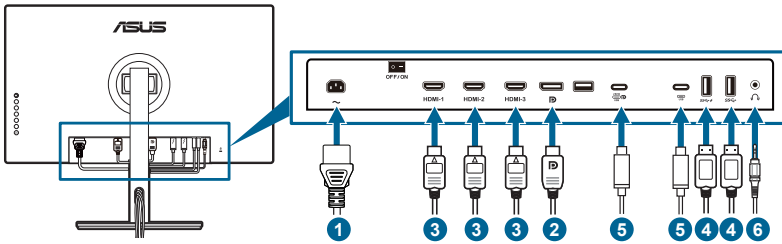

We recommend that you follow the order below to route the cable through the cable management slot on the stand.

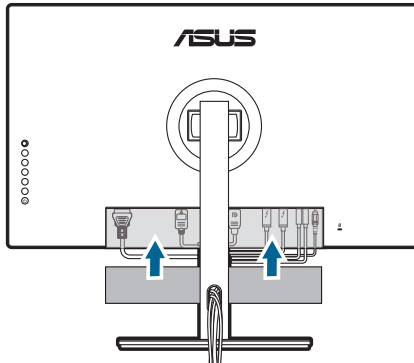

3. Attach the input/output port cover if needed.



2.5 Turning on the monitor

Press the power button . See page 1-2 for the location of the power button. The power indicator  lights up in white to show that the monitor is ON.

3.1 OSD (On-Screen Display) menu

3.1.1 How to reconfigure

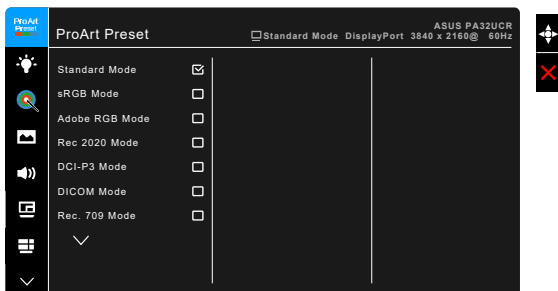

1. Press the Menu (5-way) button to activate the OSD menu.
2. Move the Menu (5-way) button up/down/left/right to navigate through the functions. Highlight the desired function and press the Menu (5-way) button to activate it. If the function selected has a sub-menu, move the Menu (5-way) button up/down to navigate through the sub-menu functions. Highlight the desired sub-menu function and press the Menu (5-way) button or move the Menu (5-way) button to activate it.
3. Move the Menu (5-way) button up/down to change the settings of the selected function.
4. To exit and save the OSD menu, press the button or move the Menu (5-way) left repeatedly until the OSD menu disappears. To adjust other functions, repeat steps 1-3.

3.1.2 OSD function introduction

1. ProArt Preset

This function contains 13 sub-functions you can select for your preference. Each mode has the Reset selection, allowing you to maintain your setting or return to the preset mode.



To activate this function, you need to do the following: turn off Ambient Effect and disable HDR on your device.



- **Standard Mode:** Best choice for document.
- **sRGB Mode:** Compatible with sRGB color space, sRGB mode is the best choice for document editing.
- **Adobe RGB Mode:** Compatible with Adobe RGB color space.
- **Rec. 2020 Mode:** Compatible with Rec. 2020 color space.
- **DCI-P3 Mode:** Compatible with DCI-P3 color space.
- **DICOM Mode:** Compliant with DICOM standard, best choice for medical image checking.
- **Rec. 709 Mode:** Compatible with Rec.709 color space.
- **HDR_PQ DCI:** Presents ST2084 with DCI-P3 color gamut and D65 white point.
 - * PQ Optimized: Delivers the optimized HDR performance of this display with as much accuracy as with ST2084 in terms of display luminance capability.
 - * PQ Clip: Preserves PQ curve till displaying maximum luminance with accuracy. ST2084 code value with higher than display maximum will be mapped to the maximum luminance. We also provide a maximum of 300 nits for your use.
 - * PQ Basic: Presents HDR performance of general HDR supported displays.
- **HDR_PQ Rec2020:** Presents ST2084 with Rec.2020 color gamut and D65 white point.

- * PQ Optimized: Delivers the optimized HDR performance of this display with as much accuracy as with ST2084 in terms of display luminance capability.
 - * PQ Clip: Preserves PQ curve till displaying maximum luminance with accuracy. ST2084 code value with higher than display maximum will be mapped to the maximum luminance. We also provide a maximum of 300 nits for your use.
 - * PQ Basic: Presents HDR performance of general HDR supported displays.
- **HDR_HLG BT2100:** Compliant with BT2100.
 - **HDR_HLG DCI:** Compliant with DCI-P3.
 - **User Mode 1/User Mode 2:** Allows you to make color adjustments in the Advanced Setting. You can also save one or two ProArt Calibration profiles as User Mode 1/User Mode 2 after executing ProArt Calibration and then have quick access here.



Please apply the following settings while performing ProArt color calibration:

- Set output dynamic to full range.
- Set output color format to RGB.
- Set output color depth to 8 bit.

Below tables show the default configurations for each ProArt Preset mode:

Function	Standard Mode	sRGB Mode	Adobe RGB Mode	Rec. 709 Mode
Color Temp.	6500K	Fixed 6500K	Fixed 6500K	6500K
Brightness	50	Fixed 80 nits	160 nits	100 nits
Contrast	80	80	80	80
Sharpness	Enable (0)	Enable (0)	Enable (0)	Enable (0)
Saturation	Middle (50)	Disable	Middle (50)	Middle (50)
Hue	Middle (50)	Disable	Middle (50)	Middle (50)
ProArt Palette/Color	Enable (default)	Disable	Enable (default)	Enable (default)
Black Level	Enable (default)	Enable (default)	Enable (default)	Enable (default)
Gamma	Enable (2.2)	Fixed 2.2	Fixed 2.2	Enable 2.4
Uniformity Compensation	Enable (Off)	Enable (Off)	Enable (Off)	Enable (Off)
Input Range	Enable (Auto)	Enable (Auto)	Enable (Auto)	Enable (Auto)

Function	DCI-P3 Mode	Rec. 2020 Mode	DICOM Mode	HDR_PQ DCI Mode
Color Temp.	P3-Theater	6500K	6500K	Fixed (6500K)
Brightness	48 nits	100nits	50	300nits/600nits/ 1000nits/Max
Contrast	80	80	80	Disable
Sharpness	Enable (0)	Enable (0)	Enable (0)	Enable (0)
Saturation	Middle (50)	Middle (50)	Middle (50)	Disable
Hue	Middle (50)	Middle (50)	Middle (50)	Disable
ProArt Palette/Color	Enable (default)	Enable (default)	Enable (default)	Enable (RGB Gain)
Black Level	Enable (default)	Enable (default)	Enable (default)	Enable (default)
Gamma	Enable (2.2/2.6 only)	Enable (2.4)	Fixed 2.2	Disable
Uniformity Compensation	Enable (Off)	Enable (Off)	Enable (Off)	Disable
Input Range	Enable (Auto)	Enable (Auto)	Enable (Auto)	Enable (Auto)

Function	HDR_PQ Rec2020 Mode	HDR_HLG BT2100 Mode	HDR_HLG DCI Mode	User Mode 1/User Mode 2
Color Temp.	Fixed (6500K)	Fixed 6500K	Fixed 6500K	6500K
Brightness	300nits/600nits/ 1000nits/Max	100	100	50
Contrast	Disable	Disable	Disable	80
Sharpness	Enable (0)	Enable (0)	Enable (0)	Enable (0)
Saturation	Disable	Disable	Disable	Middle (50)
Hue	Disable	Disable	Disable	Middle (50)
ProArt Palette/ Color	Enable (RGB Gain)	Enable (RGB Gain)	Enable (RGB Gain)	Disable
Black Level	Enable (default)	Enable (default)	Enable (default)	Enable (default)
Gamma	Disable	Disable	Disable	Fixed 2.2
Uniformity Compensation	Disable	Disable	Disable	Fixed Off
Input Range	Enable (Auto)	Enable (Auto)	Enable (Auto)	Enable (Auto)

2. Blue Light Filter

In this function, you can adjust the blue light filter level.



To activate this function, you need to do the following: turn off Ambient Effect and disable HDR on your device.

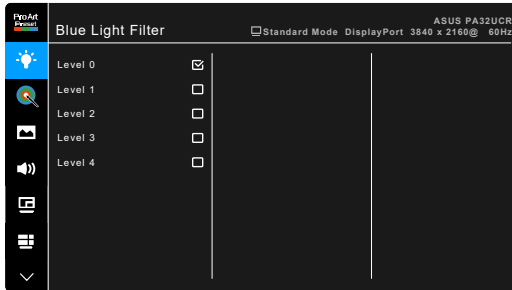

- **Level 0:** No change.
- **Level 1~4:** The higher the level, the less blue light is scattered. When Blue Light Filter is activated, the default settings of Standard Mode will be automatically imported. Between Level 1 to Level 3, the Brightness function is user-configurable. Level 4 is optimized setting. It is compliant with TUV Low Blue Light Certification. The Brightness function is not user-configurable.



Please refer to the following to alleviate eye strains:

- Users should take some time away from the display if working for long hours. It is advised to take short breaks (at least 5 mins) after around 1 hour of continuous working at the computer. Taking short and frequent breaks is more effective than a single longer break.
- To minimize eye strain and dryness in your eyes, users should rest the eye periodically by focusing on objects that are far away.
- Eye exercises can help to reduce eye strain. Repeat these exercises often. If eye strain continues please consult a physician. Eye exercises: (1) Repeating look up and down (2) Slowly roll your eyes (3) Move your eyes diagonal.
- High energy blue light may lead to eye strain and AMD (Age-Related Macular Degeneration). Blue light Filter to reduce 70% (max.) harmful blue light to avoiding CVS (Computer Vision Syndrome).

3. ProArt Palette

Set a desired color setting from this menu.



To activate this function, you need to do the following: turn off Ambient Effect and disable HDR on your device.

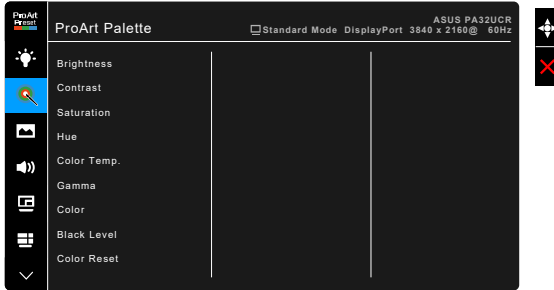

- **Brightness:** The adjusting range is from 0 to 100.
- **Contrast:** The adjusting range is from 0 to 100.
- **Saturation:** The adjusting range is from 0 to 100.
- **Hue:** Shifts the image color between green and purple.
- **Color Temp.:** Contains 5 modes including 9300K, 6500K, 5500K, 5000K and P3-Theater.



P3-Theater is only available when DCI-P3 mode is selected.

- **Gamma:** Allows you to set the color mode to 2.6, 2.4, 2.2, 2.0 or 1.8.
- **Color:**
 - * Six-axis Hue adjustment.
 - * Six-axis Saturation adjustment.
 - * Adjusts the gain levels for R, G, B.
 - * Adjusts the black level offset values for R, G, B.
- **Black Level:** The darkest level of display.
 - * Signal: To adjust the initialized 1st signal level of darkest gray level.
 - * Backlight: To adjust the darkness of backlight.
- **Color Reset:**
 - * Current mode color reset:
Resets the color settings of current color mode to the factory default value.

- * All modes color reset:
Resets the color settings of all color modes to the factory default value.

4. Image

Set the image related setting from this menu.



- **Sharpness:** The adjusting range is from 0 to 100.
- **Trace Free:** Adjusts the response time of the monitor.



To activate this function, you need to do the following: turn off PBP and disable HDR on your device.

- **Aspect Control:** Adjusts the aspect ratio to full, 4:3, 1:1 or OverScan.
 - To activate this function, you need to do the following: turn off PBP.
 - 4:3 is only available when input source is in 4:3 format. OverScan is only available for the HDMI input source.



- **Uniformity Compensation:** Adjusts different areas of the screen to reduce any screen uniformity errors, providing consistent brightness and color across the entire screen.



To activate this function, you need to do the following: turn off Dynamic Dimming and disable HDR on your device.

- **Input Range:** To map signal range with whole black to white presented range of display.
- **Motion Sync:** Simulates display as high refresh rate performance to generate different backlight frequencies.



To activate this function, you need to do the following: turn off Ambient Effect.

5. Sound

You can adjust Volume, Mute and Source from this menu.

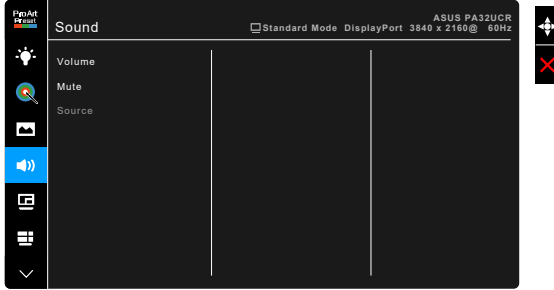

- **Volume:** the adjusting range is from 0 to 100.
- **Mute:** toggles the monitor sound between on and off.
- **Source:** decides the monitor sound comes from which source.

6. PIP/PBP Setting

The PIP/PBP Setting allows you to open up another sub-window connected from another video source besides the main-window from your original video source. By activating this function, the monitor displays up to 4 pictures from different video sources (when input source is below 4K@60Hz).



To activate this function, you need to do the following: turn off Dynamic Dimming, turn off Adaptive-Sync and disable HDR on your device.



- **PIP/PBP Mode:** Selects PIP, PBP, PBP x 3 or PBP x 4 function, or turn it off.

- **PIP/PBP Source:** Selects the video input source from among HDMI-1, HDMI-2, HDMI-3, DisplayPort, and USB Type-C. The table below shows the input source combinations.



		Main-window				
		HDMI-1	HDMI-2	HDMI-3	DisplayPort	USB Type-C
Sub-window	HDMI-1	Yes	Yes	Yes	Yes	Yes
	HDMI-2	Yes	Yes	Yes	Yes	Yes
	HDMI-3	Yes	Yes	Yes	Yes	Yes
	DisplayPort	Yes	Yes	Yes	Yes	Yes
	USB Type-C	Yes	Yes	Yes	Yes	Yes

- **Color Setting:** Selects an individual Splendid Mode for the selected PBP source. (Up to 2 Splendid Modes can be chosen.)

7. QuickFit Plus

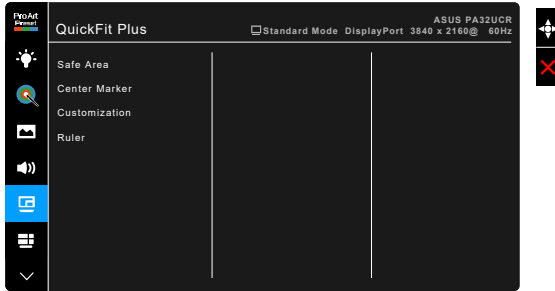
In this function, you can use different kinds of alignment patterns.



- **Safe Area:** Facilitates designers and users to organize content and layout on one page and achieve a consistent look and feel. The selections are: 1:1, Action Safe, Title Safe, 3 x 3.
- **Center Marker:** Adjusts the Type 1, Type 2, Type 3.
- **Customization:** You can decide the frame size by moving the  Menu (5-way) button up/down/left/right. You can press the  Menu (5-way) button for longer than 3 seconds to switch the measurements between millimeter and inch.
- **Ruler:** This pattern presents physical ruler on top and left side. You can press the  Menu (5-way) button for longer than 3 seconds to switch the measurements between metric and imperial.

8. Input Select

In this function, you can select your desired input source.

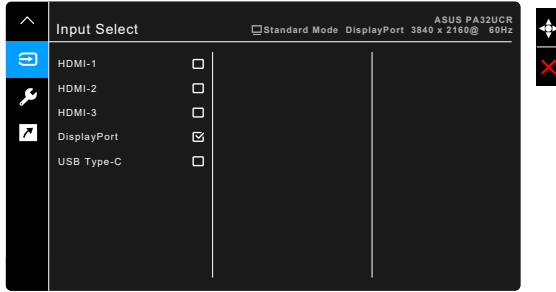

9. System Setup

Allows you to adjust the system.

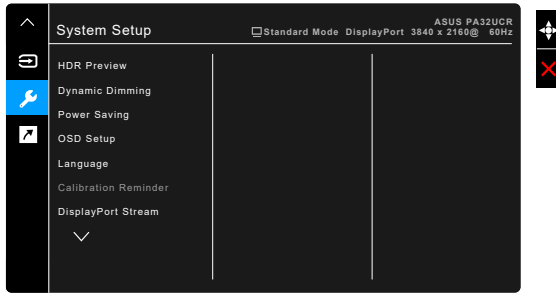

- **HDR Preview:** Allows you to preview non-HDR content performance with HDR10 and HLG mapping. While HDR Preview function is on, HDR_PQ DCI, HDR_PQ Rec2020, HDR_HLG BT2100 and HDR_HLG DCI can be chosen.
- **Dynamic Dimming:** Synchronizes with contents while contrast changing to execute backlight dynamic dimming. You can adjust the synchronization speed as “Fast”, “Medium” or “Gradual”.



To activate this function, you need to do the following: turn off PBP.

- **Power Saving:**
 - * “Normal Level” allows the USB downstream ports/USB Type-C ports to charge external devices when the monitor enters power saving mode.

- * “Deep Level” does not allow all ports to charge external devices and keeps USB Type-C and USB signals from being automatically detected when the monitor enters power saving mode.
- **OSD Setup:**
 - * Adjusts the OSD timeout from 10 to 120 seconds.
 - * Enables or disables the DDC/CI function.
 - * Adjusts the OSD background from opaque to transparent.
 - * Adjusts the OSD rotation.
- **Language:** There are 21 languages for your selection, including English, French, German, Italian, Spanish, Dutch, Portuguese, Russian, Czech, Croatian, Polish, Romanian, Hungarian, Turkish, Simplified Chinese, Traditional Chinese, Japanese, Korean, Thai, Indonesian, Persian.
- **Calibration Reminder:** To remind user of calibrating this monitor to ensure color accuracy every working period. There are 3 alarms (300/600/1000 hours) and OFF for user’s preference.



This function is enabled when User Mode 1 or User Mode 2 is selected.

- **DisplayPort Stream:** Compatibility with graphic card. Select DisplayPort 1.1 or DisplayPort 1.2 by graphic card DP version.



DisplayPort 1.1 is only available when Adaptive-Sync is off.

- **Key Lock:** To disable all function keys. Press the second button from the top over five seconds to cancel the key lock function.
- **Power Indicator:** Turns the power LED indicator on/off.
- **Ambient Effect:** Synchronizes display brightness with ambient light changes.



To activate this function, you need to do the following: disable HDR on your device, turn off Motion Sync and set Blue Light filter to Level 0.

- **Information:** Shows the monitor information.
- **All Reset:** “Yes” allows you to restore the default settings.

10. Shortcut

Defines the functions for Shortcut 1 and 2 buttons.

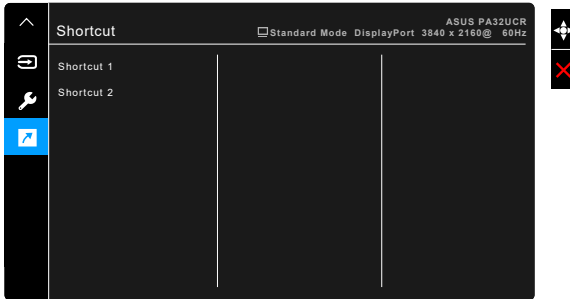

- **Shortcut 1/Shortcut 2:** selects a function for Shortcut 1 and 2 buttons.



When a certain function is selected or activated, your shortcut key may not support. Available function choices for shortcut: Blue Light Filter, Brightness, HDR, Contrast, PIP/PBP Setting, Color Temp., Volume, Motion Sync, User Mode 1, User Mode 2.

3.2 Specifications summary

Panel Type	TFT LCD
Panel size	32.0" (16:9, 81.28 cm) wide screen
Max. Resolution	3840 x 2160
Pixel pitch	0.1845 mm
Brightness	400 cd/m ² (Typ.), 1000 cd/m ² (Max.)
Contrast Ratio (Typ.)	1,000:1
Contrast Ratio (Max.)	100,000,000:1 (with Dynamic Dimming on)
Viewing angle (H/V) CR>10	178°/178°
Display colors	1.07 billion
Color gamut	DCI-P3: 98% / Rec2020: 87%
Response time	5 ms (Gray to gray)
ProArt Preset selection	14 color preset modes
Color temperature selection	5 color temperatures
Digital input	HDMI v2.0b, DisplayPort v1.2, USB Type-C
Earphone jack	Yes
USB 3.0 port	Downstream x 2
Color	Black
Power LED	White (On)/Amber (Standby)
Tilt	+23° ~ -5°
Swivel	+30° ~ -30°
Pivot	+90°; -90°
Height Adjustment	130 mm
Kensington lock	Yes
AC input voltage	AC: 100~240V
Power consumption	Power On: < 46 W** (Typ.), Standby: < 0.5 W (Typ.), Power Off: 0 W (Switch off)
Temperature (Operating)	0°C~40°C
Temperature (Non-operating)	-20°C~+60°C
Dimension (W x H x D)	726.88 x 604.15 x 245.0 mm (with stand, highest) 726.88 x 474.15 x 245.0 mm (with stand, lowest) 726.88 x 425.87 x 68.68 mm (without stand) 913 x 365 x 521 mm (package)
Weight (Esti.)	7.7 kg (without stand); 12.3 kg (Net); 17.7 kg (Gross)
Multi-languages	21 languages (English, French, German, Italian, Spanish, Dutch, Portuguese, Russian, Czech, Croatian, Polish, Romanian, Hungarian, Turkish, Simplified Chinese, Traditional Chinese, Japanese, Korean, Thai, Indonesian, Persian)
Accessories	Quick start guide, warranty card, power cord, HDMI cable, USB Type-C cable, DisplayPort cable, color calibration testing report, input/output port cover, ProArt welcome card, color calibrator (for PA32UCR-K only)

Compliance and Standards

cTUVus, CB, CE, FCC, CCC, BSMI, CU, VCCI, J-MOSS, RoHS, WEEE, PSE, KCC, ICES-3, ErP, CEL, ISO 9241-307, UkrSEPRO, RCM, PC Recycle, KC, e-Standby, TUV Flicker Free, TUV Low Blue Light, PSB, CEC, MEPS, Energy Star, USB IF, Windows 7, 10 and 11 WHQL, Mac Compliance****

*Specifications are subject to change without notice.

**measuring a screen brightness of 200 nits without audio/USB/Card reader connection.

***Requires Mac OS 10.13.6, 10.14.1.

3.3 Outline dimensions

ASUS PA32UCR Outline Dimension
 *Unit: mm(inch)

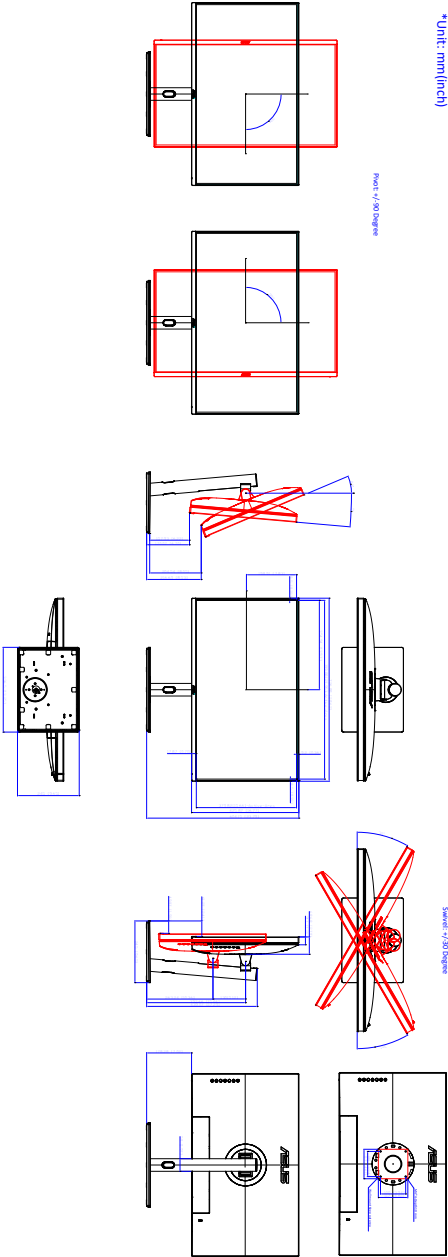

3.4 Troubleshooting (FAQ)

Problem	Possible Solution
Power LED is not ON	<ul style="list-style-type: none"> • Press the  button to check if the monitor is in the ON mode. • Check if the power cord is properly connected to the monitor and the power outlet. • Check if the power switch is ON.
The power LED lights amber and there is no screen image	<ul style="list-style-type: none"> • Check if the monitor and the computer are in the ON mode. • Make sure the signal cable is properly connected the monitor and the computer. • Inspect the signal cable and make sure none of the pins are bent. • Connect the computer with another available monitor to check if the computer is properly working.
Screen image is too light or dark	<ul style="list-style-type: none"> • Adjust the Contrast and Brightness settings via OSD.
Screen image bounces or a wave pattern is present in the image	<ul style="list-style-type: none"> • Make sure the signal cable is properly connected to the monitor and the computer. • Move electrical devices that may cause electrical interference.
Screen image has color defects (white does not look white)	<ul style="list-style-type: none"> • Inspect the signal cable and make sure that none of the pins are bent. • Perform All Reset via OSD. • Adjust the R/G/B color settings or select the Color Temperature via OSD.
No sound or sound is low	<ul style="list-style-type: none"> • Ensure that the HDMI/DisplayPort/Thunderbolt cable is properly connected to the monitor and the computer. • Adjust the volume settings of both your monitor and HDMI/DisplayPort/Thunderbolt device. • Ensure that the computer sound card driver is properly installed and activated.

3.5 Supported operating modes

Resolution Frequency	Horizontal Frequency (KHz)	Vertical Frequency (Hz)	Pixel (MHz)
640 x 350	31.47 (P)	70 (N)	25.18
640 x 480	31.47 (N)	59.94 (N)	25.18
640 x 480	37.87 (N)	72.82 (N)	31.5
640 x 480	37.5 (N)	75.00 (N)	31.5
720 x 400	31.47 (N)	70.08 (P)	28.32
800 x 600	35.16 (P)	56.25 (P)	36
800 x 600	37.88 (P)	60.32 (P)	40
800 x 600	48.08 (P)	72.12 (P)	50
800 x 600	46.86 (P)	75.00 (P)	49.5
848 x 480	31.0 (P)	60 (P)	33.75
1024 x 768	48.36 (N)	60.00 (N)	65
1024 x 768	56.476 (N)	70.069 (N)	75
1024 x 768	60.02 (N)	75.00 (N)	78.75
1152 x 864	67.5 (P/N)	75.00 (P/N)	108
1280 x 720	44.77 (N)	60	74.5
1280 x 768	47.8 (N)	60 (N)	79.5
1280 x 768	60.3 (P)	75 (P)	102.25
1280 x 800	49.7 (N)	60 (P)	84.5
1280 x 960	60.00 (P)	60.00 (N)	108
1280 x 1024	63.98 (P)	60.02 (P)	108
1280 x 1024	79.98 (P)	75.02 (P)	135
1366 x 768	47.712 (P)	59.79 (P)	85.5
1400 x 1050	65.3 (N)	60 (P)	121.75
1440 x 900	55.94 (N)	59.89 (P)	106.5
1600 x 1200	75.00 (P)	60.00 (P)	162
1680 x 1050	65.29 (N)	60.00 (P)	146.25
1920 x 1080	67.5 (P)	60.00 (P)	148.5
1920 x 1200 (Reduced Blanking)	74.038 (P)	59.95 (N)	154
1920 x 1200	74.556 (N)	59.885 (P)	193.25
1920 x 2160	133.293	59.988	277.25
2560 x 1080	66.636 (P)	59.978 (N)	181.25
2560 x 1440	88.787 (P)	59.951 (N)	241.5
3840 x 2160	52.593 (N)	24 (P)	266.75
3840 x 2160	54.786 (N)	25	278.75
3840 x 2160	67.5 (P)	30 (P)	297
3840 x 2160	111.174 (N)	50 (P)	587
3840 x 2160 (Reduced Blanking)	133.313 (P)	60 (N)	533.25
3840 x 2160	135.0 (P)	60.0 (N)	594

“P” / “N” stands for “Positive” / “Negative” polarity of incoming H-sync/V-sync (input timing). When the monitor is operating in the video mode (ie, not displaying data) using the HDMI connector, the following high definition modes shall be supported in addition to standard definition video.

Resolution	Vertical Frequency (kHz)	Horizontal Frequency (KHz)
1920 × 1080p	24Hz	27
	50Hz	56.25
	59.94Hz	67.43
	60Hz	67.5
1920 × 1080i	50Hz	28.13
	59.94Hz	33.72
	60Hz	33.75
1440 × 480P	59.94Hz	31.47
	60Hz	31.5
1440 × 576P	50Hz	31.25
1280 × 720p	50Hz	37.5
	59.94Hz	44.95
	60Hz	45
720 × 576p	50Hz	31.25
720 × 480p	59.94Hz	31.47
	60Hz	31.5
640 × 480p(VGA)	59.94Hz	31.47
	60Hz	31.5
720(1440) × 576i	50Hz	15.63
720(1440) × 480i	59.94Hz	15.73
	60Hz	15.75

* Modes not listed in the table may not be supported. For optimal resolution, we recommend that you choose a mode listed in the table above.