

SPA OWNER'S MANUAL



IMPORTANT SAFETY INSTRUCTIONS

**READ & FOLLOW ALL INSTRUCTIONS
SAVE THESE INSTRUCTIONS**

Pour voir ou imprimer ce document en Français, veuillez visiter:

<http://www.sunrisespas.com>



OM-SUNRISE-20G

INDEX

Table of Contents

BRAND CONFIGURATION TABLE	3
SAFETY SIGN	4
ATTENTION: SPA OWNER	4
CONDITIONS OF WARRANTY AND CONSUMER OBLIGATIONS	5
YOUR PERSONAL SPA DATA	6
IMPORTANT SAFETY INSTRUCTIONS	7
READ AND FOLLOW ALL INSTRUCTIONS	8
SAVE THESE INSTRUCTIONS	8
IMPORTANT SAFETY INSTRUCTIONS FOR SPAS WITH AUDIO SYSTEMS	9
INSTALLATION INSTRUCTIONS	10
ELECTRICAL CONNECTION GENERAL INFORMATION	12
NORTH AMERICAN (60HZ) MODELS	13
1) 115 VOLT CORD CONNECTION	14
2) 230 VOLT SUPPLY CONNECTION	15
EUROPEAN (50HZ) MODELS	17
TYPICAL RESIDUAL CURRENT DETECTOR (RCD)	18
230 VOLT SUPPLY CONNECTION	18
CONVERSION FROM SINGLE SERVICE TO 3-SERVICE	20
WHAT'S INSIDE YOUR SPA	22
WHAT'S UNDER YOUR SPA (THE EQUIPMENT)	25
START-UP	26
TP600 CONTROL PANEL USER GUIDE	29
BLUETOOTH READY SYSTEM OPERATION	42
ACCESSING FILTER CARTRIDGES	42
MAINTENANCE	43
FILTER SYSTEM	45
DRAINING YOUR SPA	46
WINTERIZING YOUR SPA	48
TROUBLESHOOTING YOUR SPA	49
WATER TREATMENT GUIDE	58

BRAND CONFIGURATION TABLE

Line	Model	Frame/Bottom	Filter	Keypad User Guide
	670 S	Polysteel/Tray	Whitewater (Dual)	TP600 Simplified
	770 S	Polysteel/Tray	Whitewater (Dual)	TP600 Simplified
	780 S	Polysteel/Tray	Whitewater (Dual)	TP600 Simplified
	870 S/SX	Polysteel/Tray	Whitewater (Dual)	TP600 Simplified
	880 S/SX	Polysteel/Tray	Whitewater (Dual)	TP600 Simplified
	970 S/SX	Polysteel/Tray	Whitewater (Dual)	TP600 Simplified
	980 S/SX	Polysteel/Tray	Whitewater (Dual)	TP600 Simplified

Note: The factory default for spas using the TP600 keypad is Simplified Menus. However, more keypad settings and features are possible on some spas by accessing the Standard menus within the spa pack. A spa pack set up change is required to access these settings and features within the standard menus.

Ask your dealer about the set up change required and additional keypad instructions.

CONGRATULATIONS ON THE PURCHASE OF YOUR NEW SPA

We have tried to compile a complete, easy to understand manual all about your spa and its' maintenance. Years of research and development have gone into producing the superior quality product you have purchased. Your spa is made from the highest quality material and latest technology available today. Pride and meticulous attention to detail have resulted in the spa you have chosen. With proper care, your spa will provide many years of comfort and pleasure.

Please take a few minutes now to read all of the instructions before you install your spa. This owner's manual will help you understand your spa, so you will get the most from your investment. For service and advice, do not hesitate to call your authorized dealer. Your questions will be welcomed by friendly and knowledgeable staff.

May you have as much pleasure and enjoyment using your new spa, as we had making it for you.

*We understand there are many choices in the marketplace when you are considering adding a spa to your home, so thank you for choosing a spa by Leisure Manufacturing Inc. **Enjoy!***

SAFETY SIGN

IMPORTANT NOTICE: SAFETY SIGN

Enclosed with this Owner's Manual is a Safety Sign. This sign must be permanently installed in a location that is visible to all spa users. It is the spa owner's responsibility to remind all users about safe spa use, particularly occasional users of the spa, who may not be aware of the various health and safety issues.

To obtain additional or replacement copies of the safety sign, contact your dealer.

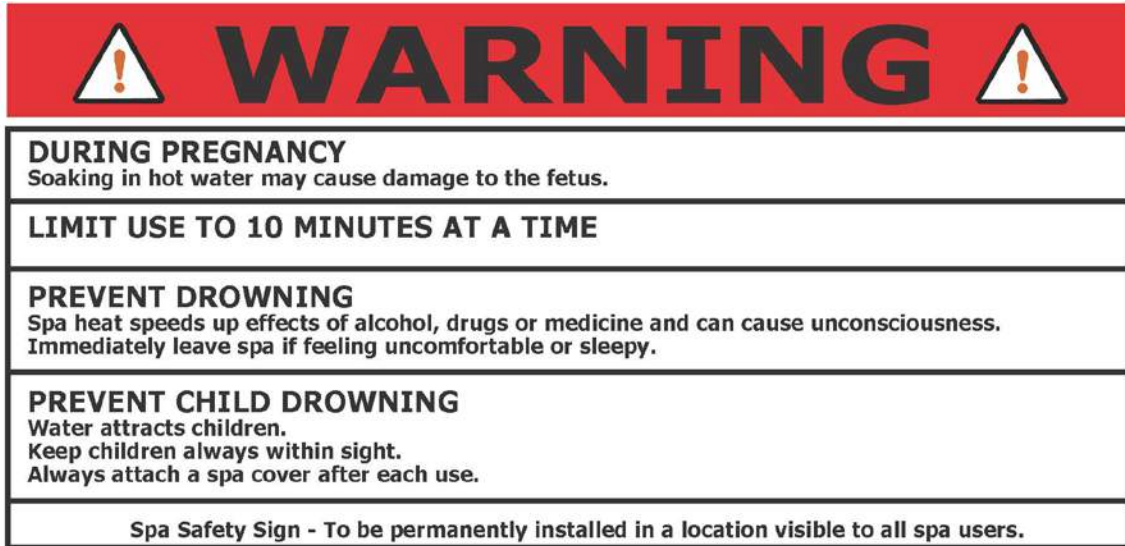

ATTENTION: SPA OWNER

In the immediate vicinity of the spa, a sign must be posted stating the following:

- 1) The spa's address
- 2) Location of the nearest telephone with posted emergency numbers
- 3) Nearest available police department, fire department and ambulance/rescue unit

CONDITIONS OF WARRANTY AND CONSUMER OBLIGATIONS

As a new spa owner, you have specific obligations in regards to the installation and safe use of this spa. Failure to do so may result in a loss of warranty coverage not to mention personal injury to those using this spa.

Inspect the spa upon its arrival for damage. If you are being made aware of this for the first time, your spa may not have been delivered in its original factory packaging. If this is the case, please take time to inspect your spa and report any damage or missing items to your dealer.

- 1) Install the spa both physically and electrically, in accordance with any local codes.
- 2) Provide suitable access to all sides of the spa. Any custom built enclosure, either above or below a deck surface, must be able to be removed with relative ease.
- 3) Provide sufficient work area around the spa's perimeter especially the side the spa's equipment is located on.
- 4) Regularly check operation of the spa in regard to filtration, jet pump operation and the heating system.
- 5) Report any concern to the dealer. Any problem that arises towards the end of particular warranty coverage should be documented and reported to the dealer
- 6) Maintain the water's chemical balance and clean/replace the system's cartridge filter(s) as instructed by the dealer and/or Leisure Manufacturing Inc.
- 7) Drain and refill the spa on a regular basis as instructed by the dealer and/or Leisure Manufacturing Inc.
- 8) Winterize and store the spa and its' components in accordance with the manufacturer's printed instructions.
- 9) Care for and maintain the spa cabinet, hard cover and acrylic surface as outlined in these instructions.
- 10) Ask your dealer to record the spa's serial number on your bill of sale.
- 11) Provide a copy of your bill of sale, if requested by the dealer or Leisure Manufacturing Inc.

YOUR PERSONAL SPA DATA

Before you begin the installation of your new spa please take a few minutes to fill out the details of your spa. This information will become invaluable later should you have a question for your dealer or should you need to make a warranty claim. Ask your dealer to assist you in recording this information.

Model Year

Model Name/Number

Spa Serial#

Jet Pump(s) Size (HP, SPL, Watts etc.)

Heater size (kw)

Filter Cartridge (Model Number/Size)

Topside Control/Keypad

Spa Pack Model #

Spa Pack Serial #

Dealer Name

Date of Purchase

We strongly recommend that you attach your bill of sale to this manual after installation is complete. Keep it in a safe place for future reference. You may also wish to attach any notes you have made about the dealer delivery, dealer start up demo or any other notes that may be of benefit in the future.

IMPORTANT SAFETY INSTRUCTIONS

WARNINGS

DANGER: Risk of Accidental Drowning. Extreme caution must be exercised to prevent unauthorized access by children. To avoid accidents, ensure that children cannot use this spa unless they are supervised at all times.

DANGER: Risk of Injury. The suction fittings in this spa are sized to match the specific water flow created by the pump. Should the need arise to replace the suction fittings or the pump, be sure that the flow rates are compatible.

Never operate spa if the suction fittings are broken or missing. Never replace a suction fitting with one rated less than the flow rate marked on the original suction fitting.

DANGER: Risk of Electric Shock. Install at least 5 feet (1.5m) from all metal surfaces. As an alternative, a spa may be installed within 5 feet of metal surfaces if each metal surface is permanently connected by a minimum 8 AWG (8.4mm²) solid copper conductor to the wire connector on the terminal box that is provided for this purpose.

DANGER: Risk of Electric Shock. Do not permit any electrical appliance, such as a light, telephone, radio, or television, within 5 feet (1.5m) of a spa.

WARNING: To reduce the risk of injury:

- a) The water in a spa should never exceed 40°C (104°F). Water temperatures between 38°C (100°F) and 40°C are considered safe for a healthy adult. Lower water temperatures are recommended for young children and when spa use exceeds 10 minutes.
- b) Since excessive water temperatures have a high potential for causing fetal damage during the early months of pregnancy, pregnant or possibly pregnant women should limit spa water temperatures to 38°C (100°F).
- c) Before entering a spa, the user should measure the water temperature since the tolerance of water temperature-regulating devices varies.
- d) The use of alcohol, drugs, or medication before or during spa use may lead to unconsciousness with the possibility of drowning.
- e) Obese persons and persons with a history of heart disease, low or high blood pressure, circulatory system problems or diabetes should consult a physician before using a spa.
- f) Persons using medication should consult a physician before using a spa since some medication may induce drowsiness while other medication may affect heart rate, blood pressure, and circulation.



CAUTION:

Maintain water chemistry in accordance with the manufacturer's instructions.

READ AND FOLLOW ALL INSTRUCTIONS

When using this equipment, basic safety precautions should always be followed. Including the following:

- a) A green coloured terminal or a terminal marked G, GR, Ground, Grounding or the international grounding symbol is located inside the supply terminal box or compartment. To reduce the risk of electric shock, this terminal must be connected to the grounding means provided in the electric supply service panel with a continuous copper wire equivalent in size to the circuit conductors supplying this equipment.
- b) At least two lugs marked "BONDING LUGS" are provided on the external surface or on the inside of the supply terminal box or compartment. To reduce the risk of electric shock, connect the local common bonding grid in area of the hot tub or spa to these terminals with an insulated or bare copper conductor not smaller than No.6 AWG.
- c) All field-installed metal components such as rails, ladders, drains or other similar hardware within 3m (10ft) of the spa or hot tub shall be bonded to the equipment grounding bus with copper conductors not smaller than No.6 AWG.

DO NOT connect your spa to an extension cord.

SAVE THESE INSTRUCTIONS IMPORTANT SAFETY INSTRUCTIONS

Hyperthermia

Prolonged immersion in hot water may induce hyperthermia. Hyperthermia occurs when the internal temperature of the body reaches a level several degrees above the normal body temperature of 37°C (98°F). The symptoms of hyperthermia include drowsiness, lethargy, and an increase in the internal temperature of the body. The effects of hyperthermia include:

- Unawareness of impending hazard
- Failure to perceive heat
- Failure to recognize the need to exit spa
- Physical inability to exit spa
- Fetal damage in pregnant women
- Unconsciousness and danger of drowning



WARNING:

The use of alcohol, drugs or medication can significantly increase the risk of fetal hyperthermia.

IMPORTANT SAFETY INSTRUCTIONS FOR SPAS WITH AUDIO SYSTEMS

CAUTION: Risk of Electric Shock. Do not leave compartment door open.

CAUTION: Risk of Electric Shock. Replace components only with identical components.

Do not operate the audio/video controls while inside the spa.

WARNING: Prevent Electrocutation. Do not connect any auxiliary components to the system (example: cable, additional speakers, headphones, additional audio/video components etc).

These units are not provided with an outdoor antenna. When provided, it should be installed in accordance with article 810 of the National Electrical Code, ANSI/NFPA 70.

Do not service this product yourself as opening or removing covers may expose you to dangerous voltage or other risk of injury. Refer all servicing to qualified service personnel.

If the power supply connections or power supply cord(s) are damaged; if water is entering the audio/video compartment or any electrical equipment compartment area; if the protective shields or barriers are showing signs of deterioration; or if there are signs of other potential damage to the unit, turn off the unit and refer servicing to a qualified service personnel.

This unit should be subjected to periodic routine maintenance (example: once every 3 months) to make sure that the unit is operating properly.

INSTALLATION INSTRUCTIONS

Remember, your new spa is a powerful piece of electrical and plumbing equipment. You owe it to yourself, your family and your friends to install it correctly and safely. Before attempting to hook-up or use your spa, please read the following instructions.



ATTENTION:

This spa is intended for outdoor use, however it can be installed indoors when precautions are taken to ensure the spa is installed and located in such a manner that any water that could leak, splash or be released as humidity will drain away harmlessly.

POSITIONING OF YOUR SPA - CONSIDERATIONS

Your spa is completely self-contained. Therefore, you can situate it just about anywhere; on a patio, in or on a deck, in a basement or sunroom. It comes completely pre-plumbed and water tested from the factory. Never lift or carry the spa by the plumbing. Damage could occur which would not be covered under warranty.

You should take into account the following when selecting prospective spa sites in order to maximize enjoyment.

To avoid any personal injury or damage to your spa, have 4-5 people ready to assist you to move the spa to its' final location. Use a moving dolly and/or straps to more evenly distribute the spa's weight. Never lift or carry the spa by its' plumbing.

SITE CONSIDERATIONS

Local codes	Local building, property and electrical codes may affect your installation.
Delivery access to location	Gates, overhangs, fences, gas meters, and AC units may become obstructions. You may need to access from a neighbour's yard or employ a crane.
Vegetation in spa area	Trees, bushes, flowers etc. can all add to spa maintenance.
Spa location relative to buildings	The location could add to your spa maintenance (removing snow from cover) and increase operating costs.
Fences, tree lines	More privacy during use and serves as a wind break but may also add more maintenance.
Spa step out location	Any surface that is slippery when wet could be dangerous for bathers both entering and exiting the spa.
Spa Direction	View when using a lounger & ease of access for servicing.
Downspouts and natural drainage of land	These may flood the spa area, damage spa or create a safety hazard to bathers.
Outside water supply and draining location	You will need a place to safely drain the spa and a way to refill it easily.
Optional accessories	These may take up added space that you must plan for (cover remover/holder).

SPA SUPPORT

Whatever the support is, it must be:

- a) A continuous, level surface, above grade, capable of handling 80 lbs. per sq. ft. that will not be compromised by changes in the water table or water sitting in the area.
- b) Such that the weight of the spa, water and bathers is not supported by the spa lip.
- c) In full contact with the bottom of the spa

ACCEPTABLE SPA SUPPORT BASES

Concrete Pad	4" to 6" thick with provision for run off
Patio Stones, Pavers etc.	Levelled with proper preparation of the earth
Wooden Deck Floor	Incl. centre support uprights in concrete and joists spaced 12" on centre
Engineered Plastic Spa Pad	Following pad manufacturer's instructions

Unacceptable Spa support bases include crushed gravel, stone dust, bare earth, platform built directly onto earth. **Damage caused by improper spa installation will void factory warranty.**

Do NOT locate your spa in a low run-off area since melting snow or rain can cause pump and equipment damage. WATER SHOULD ALWAYS DRAIN AWAY FROM THE SPA.

See next page for dimensions that can be used to determine the proper location of submerged conduits in concrete slab installations. All dimensions are made from the outside of the spa's frame with the access panels removed.



ELECTRICAL CONNECTION GENERAL INFORMATION

A. LOCATING A CONDUIT WITHIN A CONCRETE PAD

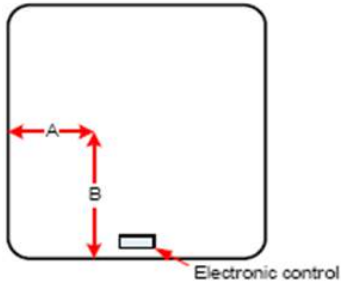

If your intent is to bring a conduit and power wires up under the spa we suggest that it enter the spa cavity in the front, left corner; 6" (15cm) Dimension A in from the left and 6" (15cm) Dimension B up from the front. See A & B on the diagram below. This location will allow you to stay clear of spa pumps and other equipment while giving you a short and easy access to the left side of the spa pack, where the electrical entry hole and terminal block are located.

B. SUPPLY CABLE ENTRY INTO SPA EQUIPMENT AREA

- You may enter the spa cavity at any other point around spa provided you have reviewed the location and determined there is no interference. You may also decide to enter at an adjoining wall (depending on the positioning of the spa) and route a conduit along the spa kicker. Ask your electrician for his/her advice in these matters.
- In all cases the best side for entry of the supply cable is the side to your left when you are standing at the equipment panel.
- Right side entry is possible; however, this may involve additional supply cable, parts and time.

HOW TO PASS THE CABLE THROUGH THE SPA ENCLOSURE

Polysteel Frame with Polyethylene Bottom and Polysteel Panels

- a) You can choose to notch the polysteel panel so you can pass the cable/conduit through and still be able to remove/replace the panel for servicing. You should consider securing the cable or conduit to the spa's metal frame where cable/conduit passes through the cabinet.
- b) You may also route a cable up under the corner. The curved panel is flexible enough and there is enough space to run the cable this way. Removing the corner may help you to do this easier.
- c) On a concrete pad where you have a conduit or cable coming up within the perimeter of the spa, you can easily cut an opening in the polyethylene bottom to access the cable or conduit/wires. See above table for recommended opening location.

You may wish to insulate any opening or cut-out you make in the spa's cabinet panel or corner or bottom to keep cold air and small animals out.

NORTH AMERICAN (60HZ) MODELS

Please note the following important information:

When using this electrical equipment, basic safety instructions should be followed, including the following:

Read and Follow ALL Directions

- 1) Electrical installation must be carried out by a qualified electrician strictly in accordance with local governing codes.
- 2) A terminal marked "ground" is located within the control box. To reduce the risk of electric shock this terminal must be connected to the grounding means provided in the electric supply service panel with a continuous copper wire equivalent in size to the circuit conductors supplying the equipment.
- 3) At least two lugs marked "bonding lugs" are provided on the external surface of the control box. To reduce the risk of electric shock connect the local common bonding grid in the area of the hot tub or spa to these terminals with an insulated or bare copper conductor not smaller than No. 6 AWG.
- 4) All field installed metal components such as rails, ladders, drains or other similar hardware within 3m (10 ft.) of the spa or hot tub shall be bonded to the equipment grounding bus with copper conductors not smaller than No. 6 AWG.
- 5) Test the ground fault circuit interrupter before each use of the spa.
- 6) Before servicing any electrical components of the system make sure that the power supply is switched off.

ATTENTION: ELECTRICIAN & SPA OWNER PICO FUSE



Balboa Spa packs contain a special fuse, referred to a "Pico fuse".

This special fuse is designed to open (burn out) if:

- a) There is any problem with how the electrical supply is connected
- b) There is a power surge to the spa pack

This fuse is not replaceable and the entire spa pack is considered destroyed.

WARNING!



THIS IS NOT A CONDITION THAT IS COVERED UNDER THE
SPA PACK MANUFACTURER'S WARRANTY OR
LEISURE MANUFACTURING'S COMPREHENSIVE SPA WARRANTY.

1) 115 VOLT CORD CONNECTION

This unit has been built, tested and approved with a cord connected 115VAC built in Ground Fault Circuit Interrupter (GFCI).

The cord must only be plugged into a receptacle that is connected to a dedicated 15A breaker or fuse.

DO NOT extend the connection by the use of an extension cord. This will void the warranty and could cause damage to the spa and its' users.

GFCI Test Procedure:

1. With the GFCI plugged into a grounded 115VAC, 15A outlet press the yellow TEST button.
2. The spa should shut off and a small light between the TEST and RESET buttons should be lighted.
3. Press the red RESET button to reset the GFCI and start the spa.



FAMILIARIZE yourself with the test procedure for the GF CI. TEST the GFCI upon every use of the spa.

If the GFCI does not shut the spa off when the TEST button is pressed or does not start up when the RESET button is pressed DO NOT USE THE SPA. Contact your dealer and/or a qualified electrician immediately. Take steps to ensure that no person(s) can use the spa while the problem is being reviewed and corrected.

Note: In new installations, GFCI trippings due to mis-wiring are very common.

If the breaker is properly wired, GFCI trippings can occur when the total amount of current drawn by the spa exceeds the rating of the breaker. Such an occurrence, however, is very unlikely, since each output of the spa pack is individually fused and fuses will blow before the GFCI trips. A current leak to the ground will also make the GFCI trip. If one or more of the components is faulty and there is a leak of more than 5 mA, the GFCI will trip to prevent electrocution.

2) 230 VOLT SUPPLY CONNECTION

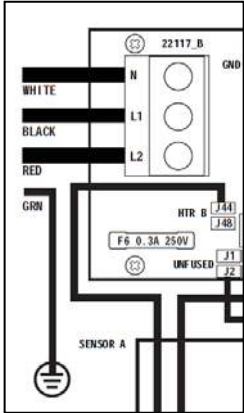

BP SERIES SPA PACK

Power Requirements

240VAC, 60Hz, Class A GFCI-protected service
4 wires (Hot-Line 1, Hot-Line 2, Neutral, Ground)
For current requirements & breaker rating see nameplate on spa.

Power Up Screen

Each time the system powers up, a series of numbers is displayed. After the start-up sequence of numbers, the system will enter Priming Mode. Next, refer to the User Guide for your keypad at the back of this manual.



CAUTION:

Electrical installation must be carried out by a qualified electrician strictly in accordance with local governing codes.
Use only Class A Ground Fault Circuit Interrupter.

TYPICAL NORTH AMERICAN GFCI

Several different models of GFCIs are available on the market.
Note that our illustrations are generic.

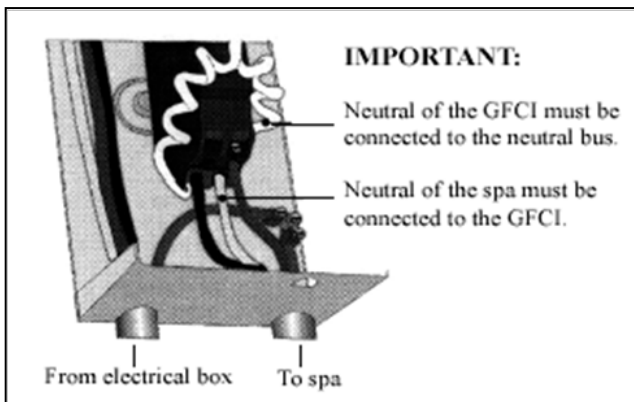

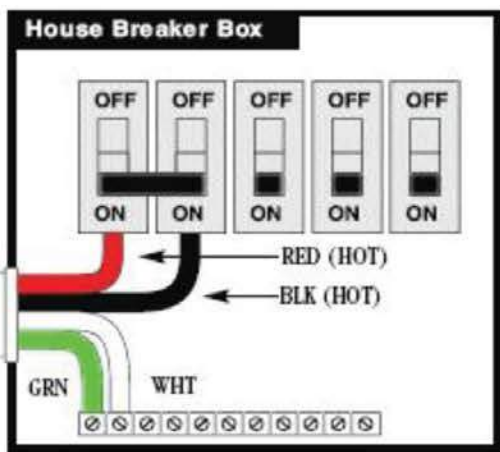

Important: Installation of this GFCI Circuit Breaker, including Ampere sizing and selection of conductor size and type, must be performed by a qualified electrician in accordance with the National Electrical Code, or the Canadian Electrical Code, and all federal, state, and local codes and regulations in effect at the time of installation.

Note: The white Neutral wire from the back of the GFCI must be connected to the incoming Line Neutral. The internal mechanism of the GFCI requires this neutral connection. The GFCI will not work without it.

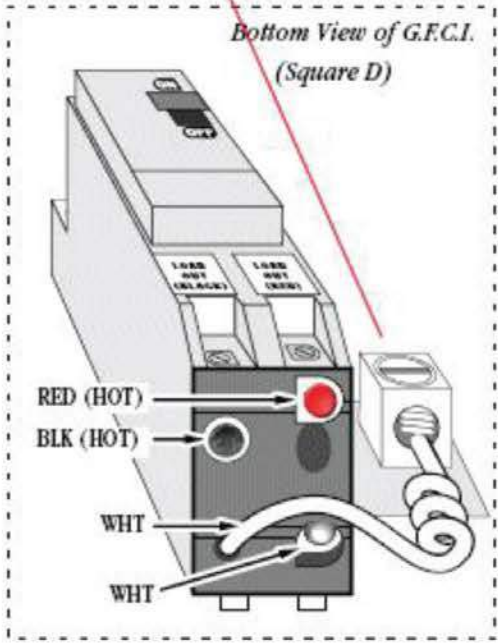
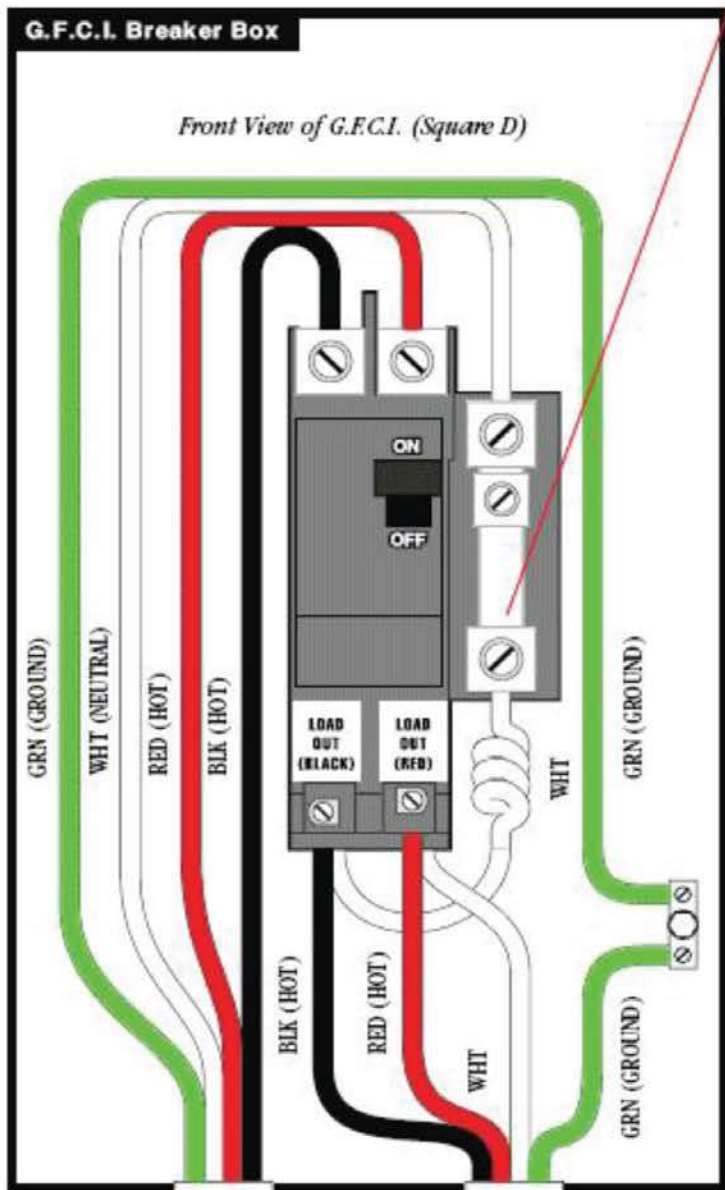

To connect spa pack, refer to electrical diagram located on next page

EUROPEAN (50HZ) MODELS

Please note the following important information:

When using this electrical equipment, basic safety instructions should be followed, including the following:

Read and Follow ALL Directions

- (1) This spa must be connected to an RCD (Residual Current Detector) with a residual operating current not exceeding 30mAmps.
- (2) Electrical installation must be carried out by a qualified electrician strictly in accordance with local governing codes.
- (3) A terminal marked "ground" is located within the control box. To reduce the risk of electric shock this terminal must be connected to the grounding means provided in the electric supply service panel with a continuous copper wire equivalent in size to the circuit conductors supplying the equipment.
- (4) At least two lugs marked "bonding lugs" are provided on the external surface of the control box. To reduce the risk of electric shock connect the local common bonding grid in the area of the hot tub or spa to these terminals with an insulated or bare copper conductor not smaller than No. 6 AWG.
- (5) Test the RCD before each use of the spa, according to the manufacturer's instructions.
- (6) Before servicing any electrical components of the system make sure that the power supply is switched off.
- (7) Keep the door closed in order to provide IPX5 protection to the electrical compartment.

Any opening made through the spa enclosure for the entry of input cables/wires, must be made watertight to preserve the IPX5 rating of the appliance.

ATTENTION: ELECTRICIAN & SPA OWNER PICO FUSE



Balboa Spa packs contain a special fuse, referred to a "Pico fuse".

This special fuse is designed to open (burn out) if:

- c) There is any problem with how the electrical supply is connected
- d) There is a power surge to the spa pack

This fuse is not replaceable and the entire spa pack is considered destroyed.

WARNING!



THIS IS NOT A CONDITION THAT IS COVERED UNDER THE
SPA PACK MANUFACTURER'S WARRANTY OR
LEISURE MANUFACTURING'S COMPREHENSIVE SPA WARRANTY.

TYPICAL RESIDUAL CURRENT DETECTOR (RCD)



A residual current device (RCD,) is the generic term for a device that monitors the current in the line conductor and the neutral conductor of a circuit in an earthed system.

In a circuit that's operating properly, the vector sum of the live and neutral current values added together will be zero. Current flowing to earth, due to a line earth fault, will return via the earth conductor, and regardless of load conditions, will be registered as a fault. This current flow will give rise to a residual current that will be detected by the device. If the residual current exceeds the rated sensitivity of the RCD, it will automatically activate a tripping of the faulty circuit.

<- Two Pole RCD

Typical specifications are as follows:

Residual Current Devices (RCD's) range

Sensitivity - from 10 to 500mA

Voltage - 2 poles : 230V; 3/4 poles: 230/400V

Connection capacity

- 25A: 6/10 mm² (flexible/ rigid cable)

- 40,60A: 16/25 mm²

- 80,100A: 35/50 mm²



<- Four Pole RCD

230 VOLT SUPPLY CONNECTION

A) SRBP601E SPA PACK

Power Requirements:

Single Service [3 wires (line, neutral, ground)]

230VAC, 50/60Hz, 1p, 16A (Circuit Breaker rating =20A max.)

Single Service [3 wires (line, neutral, ground)]

230VAC, 50/60Hz, 1p, 32A (Circuit Breaker rating =40A max.)

IMPORTANT: If you want to run this spa pack on a 1 x 32 Amp single service you must:

- Move dipswitch #2 on switchbank S1 to the ON position
- Move dipswitch #5 on switchbank S1 to the OFF position

See wiring diagram (back of cover for spa pack) for switchbank location

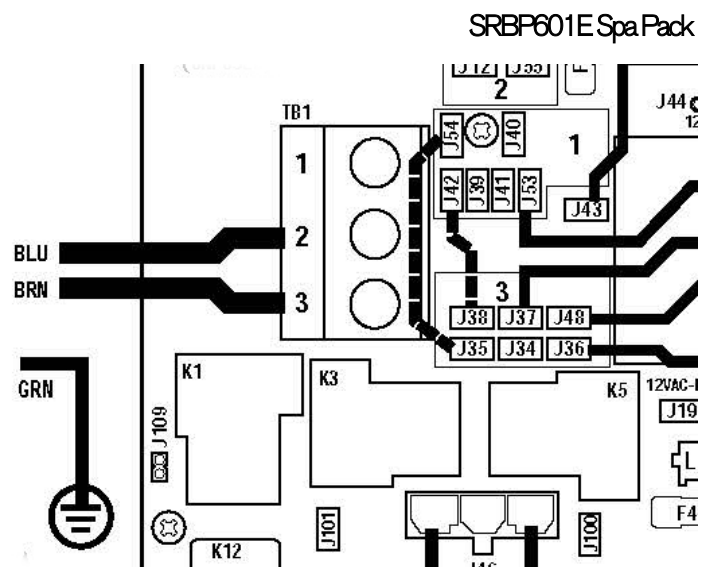

B) SRBP21X SPA PACK

Power Requirements:

Single Service [3 wires (line, neutral, ground)]
230VAC, 50Hz, 1p, 32A (Circuit Breaker rating =40A max.)

Dual Service N/A
230VAC, 50/60Hz, 1p, 32A (Circuit Breaker rating =40A max.)

3-Service [5 wires (line 1, line 2, line 3, neutral, ground)]
400VAC, 50Hz, 3p, 16A (Circuit Breaker rating =20A max each phase line.)

IMPORTANT – Service must include a neutral wire, with a line to neutral voltage of 230VAC.

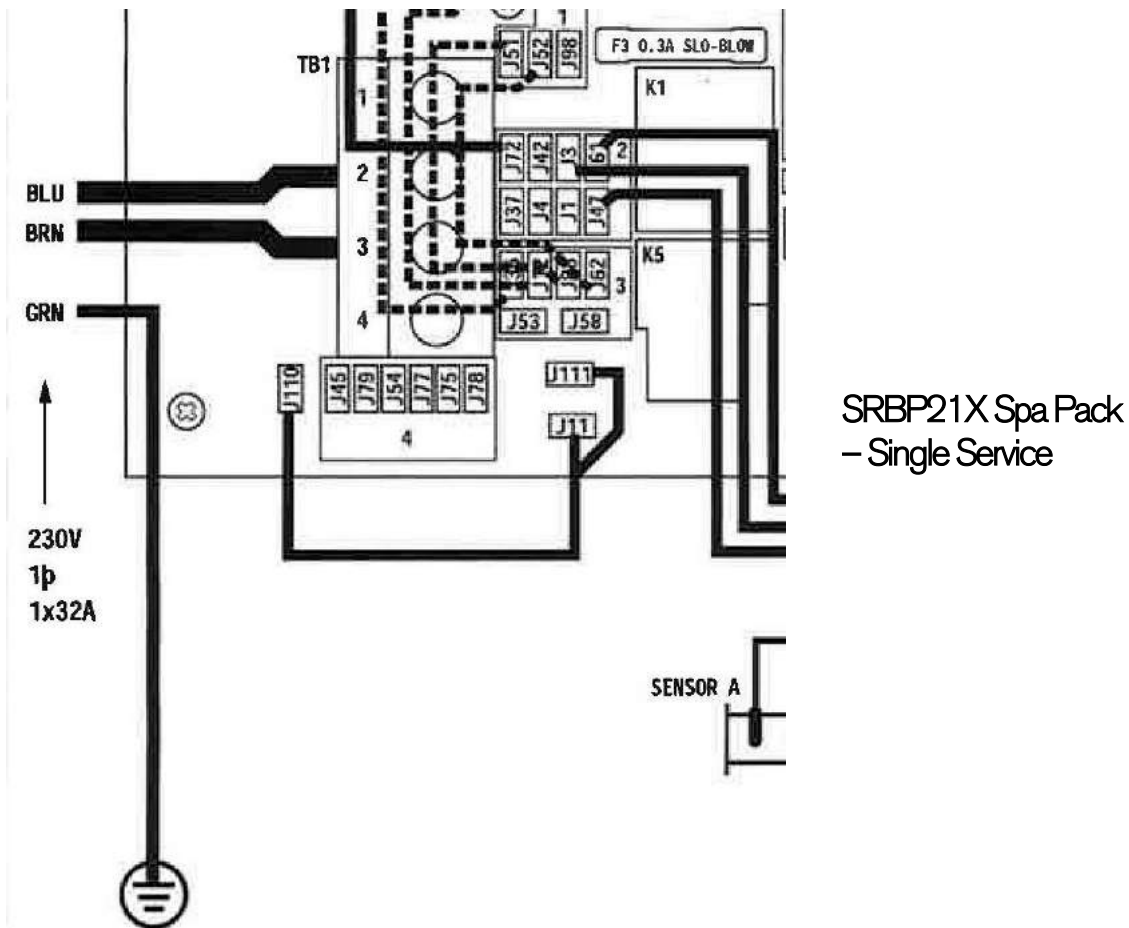

CONVERSION FROM SINGLE SERVICE TO 3-SERVICE

1. Remove the jumper wire from J51 (Area 1) to J88 (Area 2)
2. Remove the jumper wire from J52 (Area 1) to J62 (Area 2)
3. Move the jumper wire attached to J60 from J36 in Area 3 to J45 in Area 4. (J60 to J45)
4. Move the jumper wire attached to J41 from J12 in Area 3 to J79 in Area 4. (J41 to J79)
5. Set DIP Switches A2 and A5 to OFF.
6. Terminal block must be wired according to the 3-Phase illustration on the wiring diagram

1. Line 1 – Brown
2. Neutral - Blue
3. Line 2 – Brown
4. Line 3 - Brown

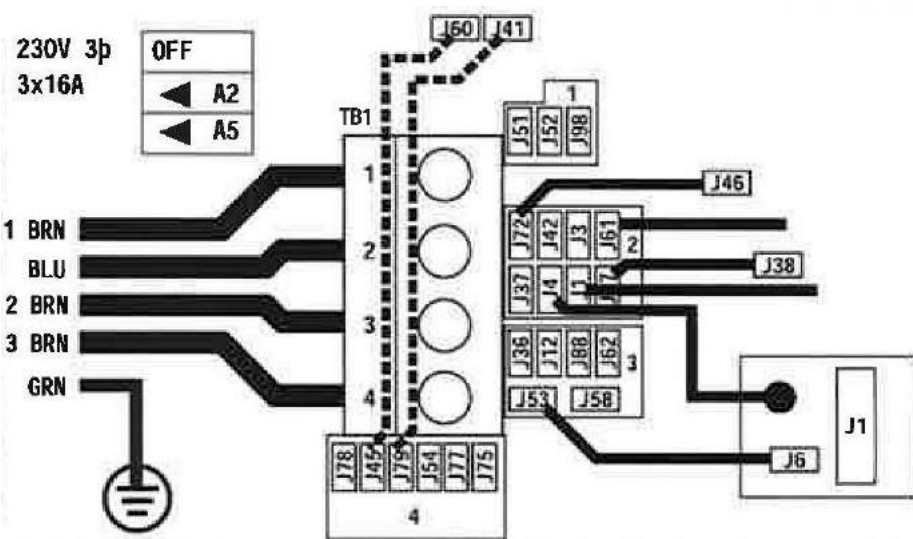

SRBP21X Spa Pack
- 3-Service

Power Up Screen

Each time the system powers up, a series of numbers is displayed. After the start-up sequence of numbers, the system will enter Priming Mode. Next, refer to the User Guide for your keypad at the back of this manual.

Wire Size and Over Current Protection (Canada/US)

Amp rating of spa		Supply Wire type and size		Over Current Protection (amps)
More than	To	60C copper, AWG	75C copper, AWG	
16	20	10	10	25
20	24	10	10	30
24	28	8	10	35
28	32	8	8	40
32	36	6	8	45
36	40	6	8	50
40	48	4	6	60

Note: If your GFCI trips immediately on start-up or during the opening use of the spa, DO NOT USE THE SPA and take precautions to ensure that no one uses the spa, while you contact your dealer/electrician. GFCI trips on newly installed spas are predominantly caused by mis-wired GFCIs.

SPECIAL NOTE: DISCONNECT SWITCH

This unit must be connected to a disconnect that de-energizes power to the entire unit for servicing, maintenance or the like. The disconnect switch, with marked "OFF" position, must be located within sight from the equipment and at least 5ft. (1.52m) from the inside walls of the spa.

SPECIAL NOTE: EMERGENCY SWITCH

This unit is intended for use in a single family dwelling. When used in locations other than a single family dwelling, a clearly labelled emergency switch, readily accessible to the occupants and at least 5ft. (1.52m) away from the unit, shall be provided as part of the installation.

Wire Size and Over Current Protection (Europe)

Total Ampere Rating of Power System	Minimum Wire Size Use Copper ONLY With 90°C Insulation	Ampere Rating of RCD Circuit-breaker
0A to 16A	#12 AWG	20
16A to 20A	#10 AWG	25
20A to 24A	#10 AWG	30
24A to 28A	#8 AWG	35
28A to 32A	#8 AWG	40







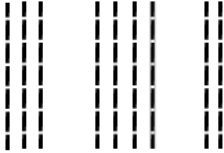

WHAT'S INSIDE YOUR SPA

HYDROTHERAPY JETS

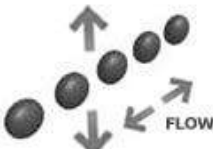
A variety of jet sizes and internal styles are used in unique seating patterns to achieve superior hydrotherapy in individual spa models. Therefore, not every jet described or pictured below is in every model. Not all jet internal styles are available in all jet sizes.

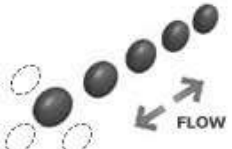
To adjust the water volume, simply turn the jet face clockwise to the off position or counter clockwise to the maximum position. If you move too hard to maximum you will release the internal from the jet body.

Jet Type	Size	Adjustable Flow	Where it is most often used
Cluster	2 1/4" (56mm)	Yes	Palm jets, loungers, seat backs, calves, neck collars
Mini	3 5/16" (84mm)	Yes	Seat backs, footwells, loungers
Poly	3 5/8" (92mm) 4 3/8" (105mm)	Yes	Seat backs, footwells, loungers
Power	5 1/4" (133mm)	Yes	Seat backs, footwells, loungers

Nozzle Type	Hydrotherapy Effect	Description
 <p>Neck Jets</p>		A soft tissue therapy jet. Draws up to 3x the air of a standard jet. Double, triple or multiple streams of air & water mixed for soothing comfort. Non volume adjustable.
 <p>Directional</p>		A steady volume adjustable stream of water with adjustable nozzle direction
 <p>Rifled</p>		A volume adjustable stream of water that gives the feel of a rotating stream of water without moving parts.
 <p>Roto/Twin Roto</p>		A volume adjustable jet with a fixed split nozzle that uses the water flow to deliver dual streams of water in a rotating pattern.
 <p>Massage</p>		A volume adjustable stream of water that rotates. The combination of the moving inner mechanism and front face gives an ever changing pattern to the massage.

OTHER INTERNAL FITTINGS



Suctions

These multi-holed, anti-vortex fittings in the footwell provide the intake water for the pump(s). A powerful suction is produced here when the jet pumps are turned on. On systems with a circulation pump, the bypass suction fitting (smaller than regular suction), may have little to no suction on it, since the circulation pump has a lower flow than the jet pump and the suction is only active as the filter(s) become clogged.

All suctions in our spas are VBG compliant for your safety.



Perimeter LED Lighting

These round or hex shaped, multi-faceted fittings, located on the vertical spa wall and deck of the spa, are the lenses for the LED light outputs.



Ozone/AquaNova Returns

These special thru wall fittings return water to your spa that has passed through the ozone or AquaNova system. If you do not have either ozone or AquaNova on your spa, these fittings will not be present.



Whitewater
(Sunrise)

Skimmer/Filter

This is the housing for your cartridge filter(s) and provides skimming action to remove surface debris. Some models have a removable basket from which debris can be dumped.

DECK CONTROLS



Air Controls

Located on the deck of the spa, these valves control the amount of air being mixed with the water stream at each jet. The minimum to maximum movement is approximately $\frac{1}{4}$ turn or on/off for toggle type. More air will increase the massage effect from the jet. Proper air draw is achieved when the jet pump is operating on high speed, particularly if the pump is a 2-speed pump.



On/off Water Valve

This positive seal valve is used to turn the water feature on/off. Adjust it as needed to achieve the best effect from the water feature.

WATER FEATURES



LED Waterfall

The LED waterfall located on a flat along the inside of the spa creates a relaxing sheet of water when turned on and adjusted using the on/off valve. When the Light key is pressed LEDs light up the waterfall body as well as the water sheet coming out of the waterfall.

MISCELLANEOUS



LED Spa Light

This clear or slightly bluish fitting is usually in the vertical surface of the spa steps. It is controlled by a designated switch on the keypad. It serves as a safety feature; lighting the spa's contours for those entering or exiting the spa.

Head Cushions

The head cushions you will find in our spas are designed to add comfort to your spa experience. Whether it is just to rest your head as you sit back and enjoy the hydrotherapy or if it is to support your neck as you let our neck collar jets soothe your aching neck and shoulders, you'll find all our head cushions functional and comfortable.



WHAT'S UNDER YOUR SPA (THE EQUIPMENT)



The spa's control pack, circulation pump, heater, drain connection and ozonator may be accessed by removing the cabinet panel along the control side of the spa. Removing the panel(s) to the right or left of the spa's main access panel will allow access to the jet pumps, blower and any other optional equipment. On some models, all equipment is accessible from the main access panel.

The **free standing spa pack** houses the receptacles and switching apparatus (circuit board) for the pump(s) blower, light, keypad etc., as well as the heat regulating system. The spa pack is also where the electrical supply connections are made. The **horizontal heater** is attached to the bottom of the spa pack.



2-Speed Jet Pump

A high performance 2-speed jet pump provides the power to operate the various hydrotherapy jets in the spa, at the optimum level. On models without a circulation pump, the low speed of the pump is used to circulate the water so it can be filtered and heated. Some models may have a 2nd jet pumps to properly power the jets. Gate valves in the plumbing lines allow easy servicing of the circ pump and heater. Safety clips on the valve shafts keep the valves open during use.



Circulation Pump (Europe Only)

The high efficiency, space saving circulation pump slowly moves water through the filter system, across the heater element and then back to the spa via the return fitting.



Ozonator

An ozonator is used to assist in water treatment. The corona discharge (CD) model produces ozone which is drawn into the spa water via the return plumbing.



O3/UV Sanitizer (AquaNova)

This unit creates both ozone and UV in perfect synergy to sanitize the spa water. Ozone introduced into the unit's chamber reacts with the UV light to create hydrogen free radicals for advanced oxidization potential (AOP). This results in only oxygen bubbles emerging from the dual return fittings.

Other items under your spa may include an audio power supply, audio receiver and LED control system.

START-UP

HOW YOUR SPA WORKS

Circulating, Heating and Filtering

Dedicated 24/7 circulation pump or low speed of a 2 speed pump (depending on model).
Immersion heating element within a stainless steel heater barrel.

Filter System

Single or two-cartridge system that is accessible from inside the spa.

Your spa may be equipped with a split filter system. One cartridge on jet pump 1 and the other on the circ pump. The clean-up cycle of the spa pack turns pump 1 on 30 minutes after you have shut it off or it times out. It will run for 30 minutes to help clean up the spa. This clean-up cycle is adjustable in 30 minute increments up to 4 hours.

Some topside controls, such as TP600, will not show a clean-up cycle adjustment, unless the set up number used is the one being used within the standard menu feature as opposed to the simplified menu. Contact your dealer to get the setup number changed. See also **Clean-up Cycle**, within the TP600 User Guide with Standard Menu feature, located in the Part B manual. See page 40-41 on how to change the clean-up cycle.

Hydrotherapy

A combination of up to three (3) single or 2-speed jet pumps provides a gentle, low-speed therapy or intense, high-speed therapy. The jets have directional nozzles, multiple directional nozzles, fixed nozzles or rotating nozzles. Most of the jets have the ability to have the water volume adjusted to your therapy needs.

Deck Controls

Air controls mix air with the water stream coming out of the jet. A diverter valve is used on some models to dedicate pump flow to specific groups of jets or share it amongst several jets. Models with the waterfall feature have a control valve to turn the waterfall on/off.

A digital topside control panel allows you to activate the pumps, blower and light plus set the temperature that you want the water to be. The topside display also shows error messages and tells you if any special spa pack features are operating, including protection against overheating and freeze-up.

Lighting

Your spa is equipped with a multi-LED spa light allowing you to enjoy the effects of a colour changing LED light system. LED lights around the perimeter of the spa create a special effect of colour changing lights.

LED Light Operation

Your spa may be equipped with an LED light system consisting of perimeter lights, lighted water feature(s), lighted jets and a thru wall underwater spa light, depending on the spa model and options. The system is controlled using the LIGHT key on the topside control panel. The spa pack is factory set/programmed for simple on/off spa light operation. Note that not all colours are available on all LED systems.

Operation: To move from setting to setting simply turn the LIGHT key on/off.

If the light is turned OFF for more than 5 seconds, the sequence automatically restarts at the last colour shown.

Light Sequence (Ultrabrite - with integrated output for additional LEDs)

Slow Cycle

White (Blue, Green and Red mix)

Aqua (Blue and Green mix)

Magenta (Blue and Red mix)

Blue

Gold (Red and Green mix)

Green

Red

Flash

Strobe

Light Sequence (Control 40/50)

White (Red, Green, Blue mix)

Aqua (Green and Blue mix)

Magenta (Blue and Red mix)

Blue

Gold (Red and Green mix)

Green

Red

Colour Flash (Quick rotation of all colours)

Slow Colour Wheel (Slow rotation of all colours)

Colour Wheel (Gradual rotation of all colours)

Light Sequence (Glo LED Jets Feature/Option Where Available – Lighted Jets)

The System uses a special MZ controller that has a unique colour sequence.

Colour Wheel (Slow fade from colour to colour)

Green

Aqua

Magenta

Blue

Red

Colour Jump (A fast change from colour to colour)

FILLING YOUR SPA

Okay, your new spa has been connected to the power and you have a basic understanding of how the equipment works and what the jets can do for you. We know you are anxious to fill the spa and get it started, but please read this section carefully before you fill your spa.

- 1) Make certain that the breaker or fuse(s) that supplies your spa equipment is off.
- 2) Wash the spa surface thoroughly with warm water and a soft cloth only to remove any construction or transportation debris.
- 3) Check that the drain connection is closed.
- 4) Check that the unions on the spa pack and pump(s) are tight. They can loosen during transportation.
- 5) Remove the filter cartridges. Open waterfall/water feature ON/OFF valve before filling. Refer to graphics on valve handle or simply turn counter clockwise to open.
- 6) Begin filling the spa with a standard garden hose. Fill by inserting hose into filter body, in the case of a lily pad style filter, or by positioning hose into a cartridge mount located in the filter well. Do not fill your spa with soft water (consult dealer). If possible, your source fill water temperature should not be less than 70°F (21°C). Do Not operate the spa with low water levels. A level 4" over the bottom of the skimmer mouth is recommended. Maximum initial water level should be 6" below the spa lip. Adjust as needed based on number of bathers using the spa. Consider adding an overflow to your spa if you are regularly having enough bathers in the spa to significantly raise the water level such that damage to equipment may occur.
- 7) Increase the fill pressure slowly to prevent surface damage by a jerking hose.
- 8) Visually check all lines for leaks and correct immediately. If you cannot stop the leak simply by tightening a union or resetting an "O" ring or gasket, contact your dealer immediately.
- 9) Turn on the main power at your electrical panel.
- 10) The topside control panel will initialize and begin its' start-up procedure. Then the system will start the circulation pump(or low speed pump) and the heater.
- 11) Re-install the filter cartridges.

IMPORTANT:

Now, read about the keypad operation, user settings, system defaults, automatic functions and display messages included in this manual (see User Guide in the Index).

Take a few minutes to try the various keys and features on your new spa.

Once you feel comfortable with the operation of your spa's controls, set the temperature to the desired level (100°F/38°C is an excellent starting point). Close the air controls and cover the spa with your hard cover. Heat up times will vary based on volume of water in the spa, but you can generally expect 6-8 hours to reach maximum temperature. Spas running on 120VAC will have a longer initial heat-up time.

Always view the temperature display before entering the water. For your own personal safety, do not enter when the temperature exceeds the maximum set point of 40°C (104°F).

TP600 CONTROL PANEL USER GUIDE

Main Menu

Navigation

Navigating the entire menu structure is done with 2 or 3 buttons on the control panel.



Some panels have separate **WARM** (Up) and **COOL** (Down) buttons, while others have a single **Temperature** button. In the navigation diagrams Temperature buttons are indicated by a single button icon.

Panels that have two Temperature buttons (Warm and Cool) can use both of them to simplify navigation and programming where a single Temperature icon is shown.

The **LIGHT** Button is also used to choose the various menus and navigate each section.

Typical use of the Temperature button(s) allows changing the Set Temperature while the numbers are flashing in the LCD. Pressing the **LIGHT** button while the numbers are flashing will enter the menus.

The menu can be exited with certain button presses. Simply waiting for several seconds will return the panel operation to normal.

Power-up Screens

Each time the System powers up, a series of numbers is displayed. After the startup sequence of numbers, the system will enter Priming Mode (See Page 3).

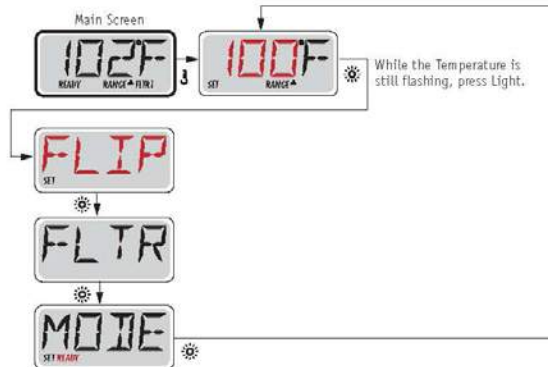

Service Technician Menu:

When Test Mode is activated by setting DIP switch 1 ON, the "TEST" menu item will appear before FLIP and the "UTIL" menu item will appear after MODE. See Service and Installation Guide for more information.

Key

- Indicates Flashing or Changing Segment
- Indicates Alternating or Progressive Message – every 1/2 second
- ↓ A temperature button, used for "Action"
- ☀ Light or dedicated "Choose" button, depending on control panel configuration
- Waiting time that keeps the last change to a menu item.
- * * * * * Waiting time (depends on menu item) that reverts to original setting and ignores any change to that menu item.



Indicates a Menu Item that Depends on a Manufacturer Configuration and may or may not appear.



Waiting Several Seconds in the Main Menu will allow the display to revert to the Main Screen. Most changes are not saved unless Light ☀ is pressed. Refer to Key above.



Manufactured under one or more of these patents: U.S. Patents: 5332944, 5361215, 5550753, 5559720, 5,883,459, 6253227, 6282370, 6590188, 6976052, 6965815, 7030343, 7,417,834 b2, Canadian Patent: 2342614, Australian patent: 2373248 other patents both foreign and domestic applied for and pending. All material copyright of Balboa Water Group.

42185_A

05-10-12

Fill it up!

Preparation and Filling

Fill the spa to its correct operating level. Be sure to open all valves and jets in the plumbing system before filling to allow as much air as possible to escape from the plumbing and the control system during the filling process.

After turning the power on at the main power panel, the top-side panel display will go through specific sequences. These sequences are normal and display a variety of information regarding the configuration of the hot tub control.

Priming Mode – M019*

This mode will last for 4-5 minutes or you can manually exit the priming mode after the pump(s) have primed.



Regardless of whether the priming mode ends automatically or you manually exit the priming mode, the system will automatically return to normal heating and filtering at the end of the priming mode. During the priming mode, the heater is disabled to allow the priming process to be completed without the possibility of energizing the heater under low-flow or no-flow conditions. Nothing comes on automatically, but the pump(s) can be energized by pushing the “Jet” buttons. If the spa has a Circ Pump, it can be activated by pressing the “Light” button during Priming Mode.

Priming the Pumps

As soon as the above display appears on the panel, push the “Jet” button once to start Pump 1 in low-speed and then again to switch to high-speed. Also, push the Pump 2 or “Aux” button, if you have a 2nd pump, to turn it on. The pumps will now be running in high-speed to facilitate priming. If the pumps have not primed after 2 minutes, and water is not flowing from the jets in the spa, do not allow the pumps to continue to run. Turn off the pumps and repeat the process. Note: Turning the power off and back on again will initiate a new pump priming session. Sometimes momentarily turning the pump off and on will help it to prime. Do not do this more than 5 times. If the pump(s) will not prime, shut off the power to the spa and call for service.

Important: A pump should not be allowed to run without priming for more than 2 minutes. Under NO circumstances should a pump be allowed to run without priming beyond the end of the 4-5 minute priming mode. Doing so may cause damage to the pump and cause the system to energize the heater and go into an overheat condition.

Exiting Priming Mode

You can manually exit Priming Mode by pressing a “Temp” button (Up or Down). Note that if you do not manually exit the priming mode as described above, the priming mode will be automatically terminated after 4-5 minutes. Be sure that the pump(s) have been primed by this time.

Once the system has exited Priming Mode, the top-side panel will momentarily display the set temperature but the display will not show the temperature yet, as shown below. This is because the system requires approximately 1 minute of water



flowing through the heater to determine the water temperature and display it.

*M019 is a Message Code. See Page 8.



Manufactured under one or more of these patents: U.S. Patents: 5332944, 5361215, 5550753, 5559720, 5,883,459, 6253227, 6282370, 6590188, 6976052, 6965815, 7030343, 7,417,834 b2, Canadian Patent: 2342614, Australian patent: 2373248 other patents both foreign and domestic applied for and pending. All material copyright of Balboa Water Group.

Spa Behavior

Pumps

Press the “Jets 1” button once to turn pump 1 on or off, and to shift between low- and high-speeds if equipped. If left running, the pump will turn off after a time-out period. The pump 1 low-speed will time out after 30 minutes. The high-speed will time out after 15 minutes.

On non-circ systems, the low-speed of pump 1 runs when the blower or any other pump is on. If the spa is in Ready Mode (See page 6), Pump 1 low may also activate for at least 1 minute every 30 minutes to detect the spa temperature (polling) and then to heat to the set temperature if needed. When the low-speed turns on automatically, it cannot be deactivated from the panel, however the high speed may be started.

Circulation Pump Modes

If the system is equipped with a circ pump, it will be configured to work in one of three different ways:

- 1, The circ pump operates continuously (24 hours) with the exception of turning off for 30 minutes at a time when the water temperature reaches 3°F (1.5°C) above the set temperature (most likely to happen in very hot climates).
- 2, The circ pump stays on continuously, regardless of water temperature.
- 3, A programmable circ pump will come on when the system is checking temperature (polling), during filter cycles, during freeze conditions, or when another pump is on.

The specific Circulation Mode that is used has been determined by the Manufacturer and cannot be changed in the field.

Filtration and Ozone

On non-circ systems, Pump 1 low and the ozone generator will run during filtration. On circ systems, the ozone will run with the circ pump.

The system is factory-programmed with two filter cycles that will run 10 minutes after power-up. The filter duration is programmable. (See page 7)

At the start of each filter cycle, the blower (if there is one) or Pump 2 (if there is one) will run briefly to purge its plumbing to maintain good water quality.

Freeze Protection

If the temperature sensors within the heater detect a low enough temperature, then the pump(s) and the blower automatically activate to provide freeze protection. The pump(s) and blower will run either continuously or periodically depending on conditions.

In colder climates, an optional additional freeze sensor may be added to protect against freeze conditions that may not be sensed by the standard sensors. Auxiliary freeze sensor protection acts similarly except with the temperature thresholds determined by the switch. See your dealer for details.

Clean-up Cycle (optional)

When a pump or blower is turned on by a button press, a clean-up cycle begins 30 minutes after the pump or blower is turned off or times out. The pump and the ozone generator will run for 30 minutes or more, depending on the system.



Manufactured under one or more of these patents: U.S. Patents: 5332944, 5361215, 5550753, 5559720, 5,883,459, 6253227, 6282370, 6590188, 6976052, 6965815, 7030343, 7,417,834 b2, Canadian Patent: 2342614, Australian patent: 2373248 other patents both foreign and domestic applied for and pending. All material copyright of Balboa Water Group.

Temperature and Temp Range

Adjusting the Set Temperature

When using a panel with Up and Down buttons (Temperature buttons), pressing Up or Down will cause the temperature to flash. Pressing a temperature button again will adjust the set temperature in the direction indicated on the button. When the LCD stops flashing, the spa will heat to the new set temperature when required.

If the panel has a single temperature button, pressing the button will cause the temperature to flash. Pressing the button again will cause the temperature to change in one direction (e.g. UP). After allowing the display to stop flashing, pressing the Temperature Button will cause the temperature to flash and the next press will change the temperature in the opposite direction (e.g. DOWN).

The temperature can be set between 60°F and 104°F.

Press-and-Hold

If a Temperature button is pressed and held when the temperature is flashing, the temperature will continue to change until the button is released. If only one temperature button is available and the limit of the Temperature Range is reached when the button is being held, the progression will reverse direction.



Manufactured under one or more of these patents: U.S. Patents: 5332944, 5361215, 5550753, 5559720, 5,883,459, 6253227, 6282370, 6590188, 6976052, 6965815, 7030343, 7,417,834 b2, Canadian Patent: 2342614, Australian patent: 2373248 other patents both foreign and domestic applied for and pending. All material copyright of Balboa Water Group.

Mode – Ready and Rest

In order for the spa to heat, a pump needs to circulate water through the heater. The pump that performs this function is known as the “heater pump.”

The heater pump can be either a 2-Speed Pump 1 or a circulation pump.

If the heater pump is a 2-Speed Pump 1, READY Mode will circulate water every 1/2 hour, using Pump 1 Low, in order to maintain a constant water temperature, heat as needed, and refresh the temperature display. This is known as “polling.”

REST Mode will only allow heating during programmed filter cycles. Since polling does not occur, the temperature display may not show a current temperature until the heater pump has been running for a minute or two.

Circulation Mode (See Page 4, under Pumps, for other circulation modes)

If the spa is configured for 24HR circulation, the heater pump generally runs continuously. Since the heater pump is always running, the spa will maintain set temperature and heat as needed in Ready Mode, without polling.

In Rest Mode, the spa will only heat to set temperature during programmed filter times, even though the water is being filtered constantly when in Circulation Mode.

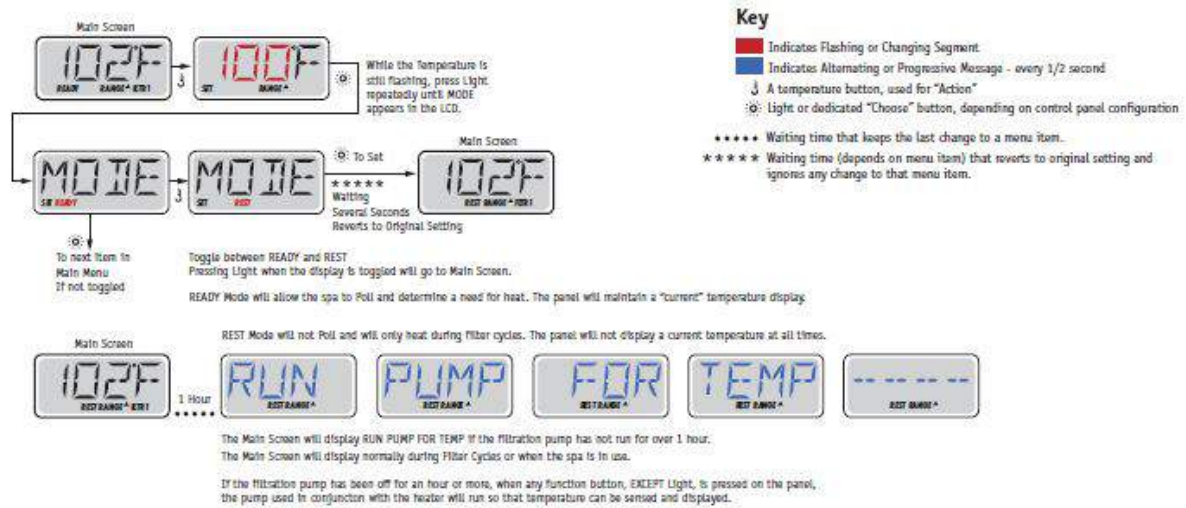

Ready-in-Rest Mode

READY/REST appears in the display if the spa is in Rest Mode and Jet 1 is pressed. It is assumed that the spa is being used and will heat to set temperature. While Pump 1 High can be turned on and off, Pump 1 Low will run until set temperature is reached, or 1 hour has passed. After 1 hour, the System will revert to Rest Mode. This mode can also be reset by entering the Mode Menu and changing the Mode.

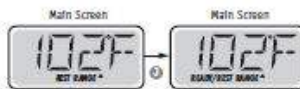

Manufactured under one or more of these patents: U.S. Patents: 5332944, 5361215, 5550753, 5559720, 5,883,450, 6253227, 6282370, 6590188, 6976052, 6965815, 7030343, 7,417,834 b2, Canadian Patent: 2342614, Australian patent: 2373248 other patents both foreign and domestic applied for and pending. All material copyright of Balboa Water Group.

42185_B

Flip (Invert Display)

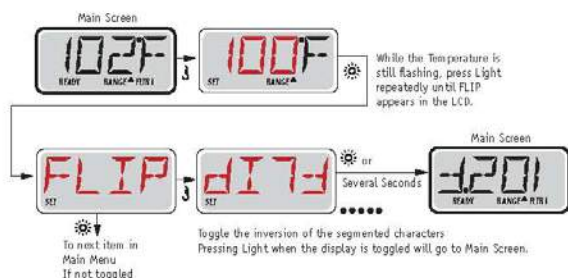

Key

- Indicates Flashing or Changing Segment
- Indicates Alternating or Progressive Message - every 1/2 second
- ⏴ A temperature button, used for "Action"
- ☀ Light or dedicated "Choose" button, depending on control panel configuration
- Waiting time that keeps the last change to a menu item.
- ***** Waiting time (depends on menu item) that reverts to original setting and ignores any change to that menu item.

Note:

Some panels may have a dedicated FLIP button, which allows the user to flip the display with a single button-press.

Adjusting Filtration

Main Filtration

Filter cycles are set using a duration. Each setting can be adjusted in 1-hour increments. Filter Cycle 1 and Filter Cycle 2 (if enabled) are set to the same duration.

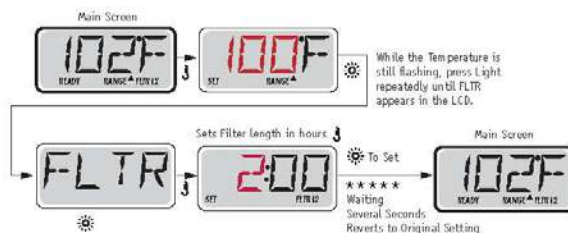

If Filter Cycle 2 is enabled, Filter 12 will appear in the LCD. If Filter is disabled, Filter 1 will appear.

Purge Cycles

In order to maintain sanitary conditions, secondary Pumps and/or a Blower will purge water from their respective plumbing by running briefly at the beginning of each filter cycle.



Manufactured under one or more of these patents: U.S. Patents: 5332944, 5361215, 5550753, 5559720, 5,883,459, 6253227, 6282370, 6590188, 6976052, 6965815, 7030343, 7,417,834 b2, Canadian Patent: 2342614, Australian patent: 2373248 other patents both foreign and domestic applied for and pending. All material copyright of Balboa Water Group.

General Messages



Priming Mode – M019

Each time the spa is powered up, it will enter Priming Mode. The purpose of Priming Mode is to allow the user to run each pump and manually verify that the pumps are primed (air is purged) and water is flowing. This typically requires observing the output of each pump separately, and is generally not possible in normal operation. Priming Mode lasts 4 minutes, but you can exit it earlier by pressing any Temp button. The heater is not allowed to run during Priming Mode.

NOTE: If your spa has a Circ Pump, it will turn on with Jets 1 in Priming Mode. The Circ Pump will run by itself when Priming Mode is exited.



Water Temperature is Unknown

After the pump has been running for 1 minute, the temperature will be displayed.



Too Cold - Freeze Protection

A potential freeze condition has been detected, or the Aux Freeze Switch has closed, and all pumps and blower are activated. All pumps and blower are ON for at least 4 minutes after the potential freeze condition has ended, or when the aux freeze switch opens.

In some cases, pumps may turn on and off and the heater may operate during Freeze Protection.

This is an operational message, not an error indication.



Water is too Hot (OHS) – M029

One of the water temp sensors has detected spa water temp 110°F (43.3°C) and spa functions are disabled. System will auto reset when the spa water temp is below 108°F (42.2°C). Check for extended pump operation or high ambient temp.



Safety Trip - Pump Suction Blockage* – M033

The Safety Trip error message indicates that the vacuum switch has closed. This occurs when there has been a suction problem or a possible entrapment situation avoided. (Note: not all spas have this feature.)

M0XX numbers are Message Codes. See Page 15.

* This message can be reset from the topside panel with any button press.



Manufactured under one or more of these patents: U.S. Patents: 5332944, 5361215, 5550753, 5559720, 5,883,459, 6253227, 6282370, 6590188, 6976052, 6965815, 7030343, 7,417,834 b2, Canadian Patent: 2342614, Australian patent: 2373248 other patents both foreign and domestic applied for and pending. All material copyright of Balboa Water Group.

Heater-Related Messages

HTR FLOW LOSS -----

Heater Flow is Reduced (HFL) – M016

There may not be enough water flow through the heater to carry the heat away from the heating element. Heater start up will begin again after about 1 min. See "Flow Related Checks" below.

HTR FLOW FAIL -----

Heater Flow is Reduced (LF)* – M017

There is not enough water flow through the heater to carry the heat away from the heating element and the heater has been disabled. See "Flow Related Checks" below. After the problem has been resolved, you must press any button to reset and begin heater start up.

HTR MAY BE DRY ----- WAIT -----

Heater may be Dry (dr)* – M028

Possible dry heater, or not enough water in the heater to start it. The spa is shut down for 15 min. Press any button to reset the heater start-up. See "Flow Related Checks" below.

HTR DRY -----

Heater is Dry* – M027

There is not enough water in the heater to start it. The spa is shut down. After the problem has been resolved, you must press any button to reset and restart heater start up. See "Flow Related Checks" below.

HTR TOO HOT -----

Heater is too Hot (OHH)* – M030

One of the water temp sensors has detected 118°F (47.8°C) in the heater and the spa is shut down. You must press any button to reset when water is below 108°F (42.2°C). See "Flow Related Checks" below.

PRES BTTN TO RSET -----

A Reset Message may Appear with other Messages.

Some errors may require power to be removed and restored.

Flow-Related Checks

Check for low water level, suction flow restrictions, closed valves, trapped air, too many closed jets and pump prime.

On some systems even when spa is shut down, some equipment may occasionally turn on to continue monitoring temperature or if freeze protection is needed.

* This message can be reset from the topside panel with any button press.



Manufactured under one or more of these patents: U.S. Patents: 5332944, 5361215, 5550753, 5559720, 5,883,459, 6253227, 6282370, 6590188, 6976052, 6965815, 7030343, 7,417,834 b2, Canadian Patent: 2342614, Australian patent: 2373248 other patents both foreign and domestic applied for and pending. All material copyright of Balboa Water Group.

Sensor-Related Messages



Sensor Balance is Poor – M015

The temperature sensors MAY be out of sync by 2°F or 3°F. Call for Service.



Sensor Balance is Poor* – M026

The temperature sensors ARE out of sync. The Sensor Balance is Poor fault has been established for at least 1 hour. Call for Service.



Sensor Failure – Sensor A: M031, Sensor B: M032

A temperature sensor or sensor circuit has failed. Call for Service.

Miscellaneous Messages



No Communications

The control panel is not receiving communication from the System. Call for Service.



Pre-Production Software

The Control System is operating with test software. Call for Service.



°F or °C is replaced by °T

The Control System is in Test Mode. Call for Service.

* This message can be reset from the topside panel with any button press.



Manufactured under one or more of these patents: U.S. Patents: 5332944, 5361215, 5550753, 5559720, 5,883,459, 6253227, 6282370, 6590188, 6976052, 6965815, 7030343, 7,417,834 b2, Canadian Patent: 2342614, Australian patent: 2373248 other patents both foreign and domestic applied for and pending. All material copyright of Balboa Water Group.

System-Related Messages

MEM FAIL -----

Memory Failure - Checksum Error* – M022

At Power-Up, the system has failed the Program Checksum Test. This indicates a problem with the firmware (operation program) and requires a service call.

MEM RSET -----

Memory Warning - Persistent Memory Reset* – M021

Appears after any system setup change. Contact your dealer or service organization if this message appears on more than one power-up, or if it appears after the system has been running normally for a period of time.

CLOK FAIL -----

Memory Failure - Clock Error* – M020 - Not Applicable on the BP1500

Contact your dealer or service organization.

CNFG FAIL -----

Configuration Error – Spa will not Start Up

Contact your dealer or service organization.

GFCI FAIL -----

GFCI Failure - System Could Not Test/Trip the GFCI – M036

NORTH AMERICA ONLY. May indicate an unsafe installation. Contact your dealer or service organization.

STUK PUMP -----

A Pump Appears to be Stuck ON – M034

Water may be overheated. POWER DOWN THE SPA. DO NOT ENTER THE WATER. Contact your dealer or service organization.

HOT FALT ----- CALL FOR SRVC -----

A Pump Appears to have been Stuck ON when spa was last powered – M035

POWER DOWN THE SPA. DO NOT ENTER THE WATER.

Contact your dealer or service organization.

* This message can be reset from the topside panel with any button press.

BALBOA
water group

Manufactured under one or more of these patents: U.S. Patents: 5332944, 5361215, 5550753, 5559720, 5,883,459, 6253227, 6282370, 6590188, 6976052, 6965815, 7030343, 7,417,834 b2, Canadian Patent: 2342614, Australian patent: 2373248 other patents both foreign and domestic applied for and pending. All material copyright of Balboa Water Group.

Reminder Messages

General maintenance helps.

Reminder Messages can be suppressed by using the PREF Menu. See Page 11.

Reminder Messages can be chosen individually by the Manufacturer. They may be disabled entirely, or there may be a limited number of reminders on a specific model.

The frequency of each reminder (i.e. 7 days) can be specified by the Manufacturer.

Press a Temperature button to reset a displayed reminder message.



Alternates with temperature or normal display.

Appears on a regular schedule, e.g. every 7 days.

Check pH with a test kit and adjust pH with the appropriate chemicals.

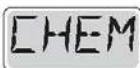
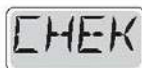

Alternates with temperature or normal display.

Appears on a regular schedule, e.g. every 7 days.

Check sanitizer level and other water chemistry with a test kit and adjust with the appropriate chemicals.



Alternates with temperature or normal display.

Appears on a regular schedule, e.g. every 30 days.

Clean the filter media as instructed by the manufacturer. See HOLD on page 6.



Alternates with temperature or normal display.

Appears on a regular schedule, e.g. every 30 days.

The Ground Fault Circuit Interrupter (GFCI) or Residual Current Device (RCD) is an important safety device and must be tested on a regular basis to verify its reliability.

Every user should be trained to safely test the GFCI or RCD associated with the hot tub installation.

A GFCI or RCD will have a TEST and RESET button on it that allows a user to verify proper function.

Warning:

If freezing conditions exist, a GFCI or RCD should be reset immediately or spa damage could result. The end user should always be trained to test and reset the GFCI or RCD on a regular basis.



Manufactured under one or more of these patents: U.S. Patents: 5332944, 5361215, 5550753, 5559720, 5,883,459, 6253227, 6282370, 6590188, 6976052, 6965815, 7030343, 7,417,834 b2, Canadian Patent: 2342614, Australian patent: 2373248 other patents both foreign and domestic applied for and pending. All material copyright of Balboa Water Group.

Reminder Messages Continued



Alternates with temperature or normal display.

Appears on a regular schedule, e.g. every 90 days.

Change the water in the spa on regular basis to maintain proper chemical balance and sanitary conditions.



Alternates with temperature or normal display.

Appears on a regular schedule, e.g. every 180 days.

Vinyl covers should be cleaned and conditioned for maximum life.



Alternates with temperature or normal display.

Appears on a regular schedule, e.g. every 180 days.

Wood skirting and furniture should be cleaned and conditioned per the manufacturers instructions for maximum life.



Alternates with temperature or normal display.

Appears on a regular schedule, e.g. every 365 days.

Filters should be replaced occasionally to maintain proper spa function and sanitary conditions.



Alternates with temperature or normal display.

As needed.

Install new mineral cartridge



Manufactured under one or more of these patents: U.S. Patents: 5332944, 5361215, 5550753, 5559720, 5,883,459, 6253227, 6282370, 6590188, 6976052, 6965815, 7030343, 7,417,834 b2, Canadian Patent: 2342614, Australian patent: 2373248 other patents both foreign and domestic applied for and pending. All material copyright of Balboa Water Group.

Warning! Qualified Technician Required for Service and Installation

Basic Installation and Configuration Guidelines

Use minimum 6AWG copper conductors only.

Torque field connections between 21 and 23 in lbs.

Readily accessible disconnecting means to be provided at time of installation.

Permanently connected.

Connect only to a circuit protected by a Class A Ground Fault Circuit Interrupter (GFCI) or Residual Current Device (RCD) mounted at least 5' (1.52M) from the inside walls of the spa/hot tub and in line of sight from the equipment compartment.

CSA enclosure: Type 2

Refer to Wiring Diagram inside the cover of the control enclosure.

Refer to Installation and Safety Instructions provided by the spa manufacturer.

Warning: People with infectious diseases should not use a spa or hot tub.

Warning: To avoid injury, exercise care when entering or exiting the spa or hot tub.

Warning: Do not use a spa or hot tub immediately following strenuous exercise

Warning: Prolonged immersion in a spa or hot tub may be injurious to your health

Warning: Maintain water chemistry in accordance with the Manufacturer's instructions.

Warning: The equipment and controls shall be located not less than 1.5 meters horizontally from the spa or hot tub.

Warning! GFCI or RCD Protection.

The Owner should test and reset the GFCI or RCD on a regular basis to verify its function.

Warning! Shock Hazard! No User Serviceable Parts.

Do not attempt service of this control system. Contact your dealer or service organization for assistance. Follow all owner's manual power connection instructions. Installation must be performed by a licensed electrician and all ground-ing connections must be properly installed.

CSA Compliance/Conformité

Caution:

- Test the ground fault circuit interrupter or residual current device before each use of the spa.
- Read the instruction manual.
- Adequate drainage must be provided if the equipment is to be installed in a pit.
- For use only within an enclosure rated CSA Enclosure 3.
- Connect only to a circuit protected by a Class A ground fault circuit interrupter or residual current device.
- To ensure continued protection against shock hazard, use only identical replacement parts when servicing.
- Install a suitably rated suction guard to match the maximum flow rate marked.

Warning:

- Water temperature in excess of 38°C may be injurious to your health.
- Disconnect the electrical power before servicing.

Attention:

- Toujours vérifier l'efficacité du disjoncteur différentiel avant d'utiliser différentiel avant d'utiliser le bain.
- Lire la notice technique.
- Lorsque l'appareillage est installé dans une fosse, on doit assurer un drainage adéquat.
- Employer uniquement à l'intérieur d'une clôture CSA Enclosure 3.
- Connecter uniquement à un circuit protégé par un disjoncteur différentiel de Class A.
- Afin d'assurer une protection permanente contre le danger de shock électrique, lors de l'entretien employer seulement des pièces de rechange identiques.
- Les prises d'aspiration doivent être équipées de grilles convenant au débit maximal indiqué.

Avertissement:

- Des températures de l'eau supérieures à 38°C peuvent présenter un danger pour la santé.
- Déconnecter du circuit d'alimentation électrique avant l'entretien.

Warning/Advertissement:

- Disconnect the electric power before servicing. Keep access door closed.
- Déconnecter du circuit d'alimentation électrique avant l'entretien. Garder la porte fermée.



Manufactured under one or more of these patents: U.S. Patents: 5332944, 5361215, 5550753, 5559720, 5,883,459, 6253227, 6282370, 6590188, 6976052, 6965815, 7030343, 7,417,834 b2, Canadian Patent: 2342614, Australian patent: 2373248 other patents both foreign and domestic applied for and pending. All material copyright of Balboa Water Group.

BLUETOOTH READY SYSTEM OPERATION

Bluetooth Operation:

If your audio player has Bluetooth capabilities, you will find it easy to stream audio to the subwoofer/amp system, especially if the audio player is larger than the dock.

1. Turn your audio device on.
2. You will hear a beep tone indicating the Bluetooth system is ready to be activated.
3. Go to "settings" on your audio player and select "Bluetooth".
4. The audio player should start searching for Bluetooth devices.
5. Once it locates this Bluetooth system, it should show "Blue Audio" and begin to connect to it.
6. If your audio player requires a code to connect to the Bluetooth subwoofer/amp, enter "0000".
7. Bluetooth should complete its' connection and show you that Blue Audio is now connected.
8. Now when you go to your audio files or other audio programs such as an Internet radio player, the sound will be streamed to the subwoofer/amp.
9. In some cases you may need to direct the audio player to play the sound to the device or to Blue Audio.

ACCESSING FILTER CARTRIDGES

Our various spa models use different filter systems depending on the spa design. Identify which filter system is in your spa and check (✓) it off for future reference.

WHITewater SKIM FILTER

Dual cartridges mounted vertically 50 sq. ft. each, 8" (20cm) high (part #PPG-50P4)

Dual cartridges mounted vertically 50 Sq. Ft. each, 6" (15.2cm) high (part #PSN-50SV-P4) (780 only)

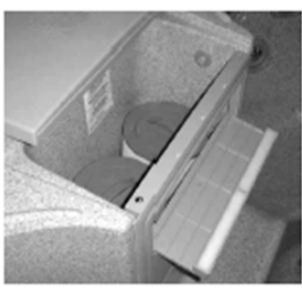

- 1) Shut off your spa at the Ground Fault Circuit Interrupter (GFCI) or Residual Current Detector (RCD).
- 2) Remove the decorative top cover.
- 3) Remove each cartridge by simply grasping the handle and turning it until it threads out of the cartridge mount.
- 4) Reverse the procedure to install new or cleaned cartridges.

MAINTENANCE

To protect the equipment and the bathers using your spa, regular maintenance must be performed.

CARING FOR THE ACRYLIC SURFACE

This beautiful acrylic surface is among the glossiest, high quality surface materials available. It's hard, non-porous surface prevents dirt from accumulating and resists stains better than other plastic materials. With normal use, it is so durable it will retain its beauty with only a minimum of care. So to maintain the high gloss and elegant look, just follow these simple steps:

- Use common household, non-abrasive cleaners for most cleaning jobs. (For example: LYSOL BASIN, TUB & TILE CLEANER, GLASS PLUS, MR.CLEAN and TOP JOB, or a mild dishwashing detergent such as IVORY LIQUID) Rinse well and dry with a clean cloth.
- Never use abrasive cleaners.
- Do not allow your acrylic surface to come into contact with products such as acetone (nail polish remover), nail polish, dry cleaning solution, lacquer thinners, gasoline, pine oil, etc.
- Remove dust and dry dirt with a soft, damp cloth.
- Clean grease, oil, paint and ink stains with isopropyl (rubbing) alcohol.
- Avoid using razor blades or other sharp instruments that might scratch the surface. Small scratches can be removed by applying a thin coat of automotive paste wax and buffing lightly with a clean cloth. For deeper scratches, sand the surface lightly with 600 grit "wet" sandpaper (never dry) and buff with fine-grit buffing compound.

If you don't rinse off any surface cleaner thoroughly, you will experience excessive foaming on refilling and start-up. Periodic application of a good wax adds lustre to the appearance and protects the finish.

CLEANING THE SPA'S CABINET

Cleaning the cabinet is easy and fast with many common household cleaners. The cleaning solution should be applied and immediately wiped dry. The cleaning solution should not be left to stand on the material for an extended period of time.

Recommended Cleaners:

Windex, Glass Plus, 409 Glass & Surface Cleaner, Spic and Span Cinch, Fantastik All-Purpose, Regency (Glass & Surface), Clorox Clean-Up and Fantastik Orange Action

Cleaners to Avoid:

Harsh cleaners with glycol ethers or ethanol type solvents and/or isopropyl alcohol soften the coating if left on for several minutes.

Cleaners such as Goof Off, Great Value All Purpose Cleaner (Wal-Mart), 409 General Purpose, Greased Lightning, citrus cleaners, abrasive cleaners and solvents such as acetone, paint remover and lacquer thinner are **NOT** recommended for cleaning the cabinet.

REINSTALLING A POLYSTEEL CABINET PANEL

If you look along the bottom section of the metal frame you should find two small pilot holes, each probably about a third of the way in from each corner. If you place a screw in each hole (just a couple turns), you can then rest the panel on top of these screws to balance it.

SPA HARD COVER

In an uncovered spa, over 90% of the heat loss is from the spa surface. The evaporation also affects the chemical balance and could create humidity problems indoors.

Hard covers are engineered for maximum thermal efficiency and appearance. They are hinged in the middle for easier handling, and the zippers allow the tapered Styrofoam inserts to be changed if damaged.

The skirt on the cover hugs the lip of the spa for a tight fit. The handles are placed so even a large cover can be easily opened by 1 person.

The locks, with one part fastened to the deck or skirt, prevent small children or animals from entering the spa.

- Do not drag the cover across the spa or decking. Fold cover first, and then remove with assistance.
- Do not place the spa where snow loads are excessive on the cover. If snow accumulates on the cover, carefully remove the snow.
- Do not shovel the snow as the cover will tear.
- Do not stand on the hard cover. The cover is not warranted against the foam breaking or the vinyl cover tearing.
- Do not use abrasive cleaners or leather restoration-type cleaners. Use only water and a mild detergent.

JET MAINTENANCE

Several of the jets in your spa are volume adjustable. The volume adjustment of the jet internals in these jets can be effected by debris in the spa water. If you feel the volume adjustment getting stiff, you should consider removing and washing the internal at the next scheduled fill and drain of the spa.

To Remove an Adjustable Jet Internal

- 1) Turn the jet face to the maximum volume position (fully counter clockwise).
- 2) The jet face will feel as if it has stopped but if you continue to turn the face, the jet internal will thread out of the body.
- 3) Check the inside of the jet body and the internal for any debris and calcium build up.
- 4) Wipe out the inside of the jet body, if necessary.
- 5) Wash the internal in your service sink. Scrub, gently, if necessary.
- 6) To re-install a jet internal simply thread the internal in until it stops. Now continue turning until the internal locks into its volume adjustment range.

If you find high levels of calcium build up or any discoloration of the jet internal when removed, you should take a spa water sample to your dealer for testing.

FILTER SYSTEM

GENERAL INFORMATION

You will need to regularly inspect your filter cartridges to ensure they are clean. As your cartridges get dirtier they could effect:

- **Heating of the spa water:** restricted water flow from a clogged filter can cause error codes to display on the control pad and prevent the spa from heating properly
- **Water quality:** a change in function of the ozone injection system can result in a drop, or complete stop, of ozone draw into the spa water

Keeping a second set of cartridges and rotating out dirty ones for clean ones can help keep your water clean and sparkling, reduce chemical consumption and down time due to cartridge cleaning.

SPECIAL NOTE: Several replacement cartridges look similar. Using the wrong cartridge may cause problems. Ask your dealer for the code that identifies your cartridge and record it.

CLEANING FILTER CARTRIDGES

- 1) Remove large debris by separating cartridge folds and spraying with a stream of water. Your kitchen or laundry sink is useful for this.
- 2) Contaminants that cause the cartridge to become brownish or greyish in colour require soaking overnight in specially formulated cartridge cleaner (available from your dealer).
- 3) Use a large plastic pail and follow the package directions. For safety reasons, you should locate your soaking pail out of reach of children.
- 4) Rinse the cartridge thoroughly to remove all the cleaner.
- 5) Allow cleaned cartridge to dry completely before re-using.
- 6) Spread pleats and run a soft brush through each one individually to complete the cleaning process.



DRAINING YOUR SPA

KNOWING WHEN TO DRAIN

Dissolved solids from bather load and ongoing chemical treatment accumulate in your spa water. The early sign of a high level of dissolved solids is unmanageable cloudy water.

When in doubt, remember that the best chemical for your spa is fresh water!

HOW TO DRAIN YOUR SPA

- 1) Turn down the set point on your spa and allow adequate time for the water to cool down. Uncover and run high speed pump to speed up cooling.
- 2) Turn power off to your spa.
- 3) Attach the appropriate size hose to the drain connection (see below).
- 4) Route the hose to an appropriate drain location.
- 5) When the drain is opened the spa will gravity drain, even unattended.
- 6) As draining proceeds, move water from contours of seats, into the footwell. Draining will stop due to drain height.
- 7) Remove any remaining water with a shop vac, sponge and pail or simply dilute in your fresh fill.
- 8) Before refilling, clean spa surface as necessary.
- 9) Don't forget to close the drain before refilling.

If you want to speed up the draining process, simply use a submersible sump pump available through most hardware stores.

MAGIC Drain Connection (Outer Cabinet)

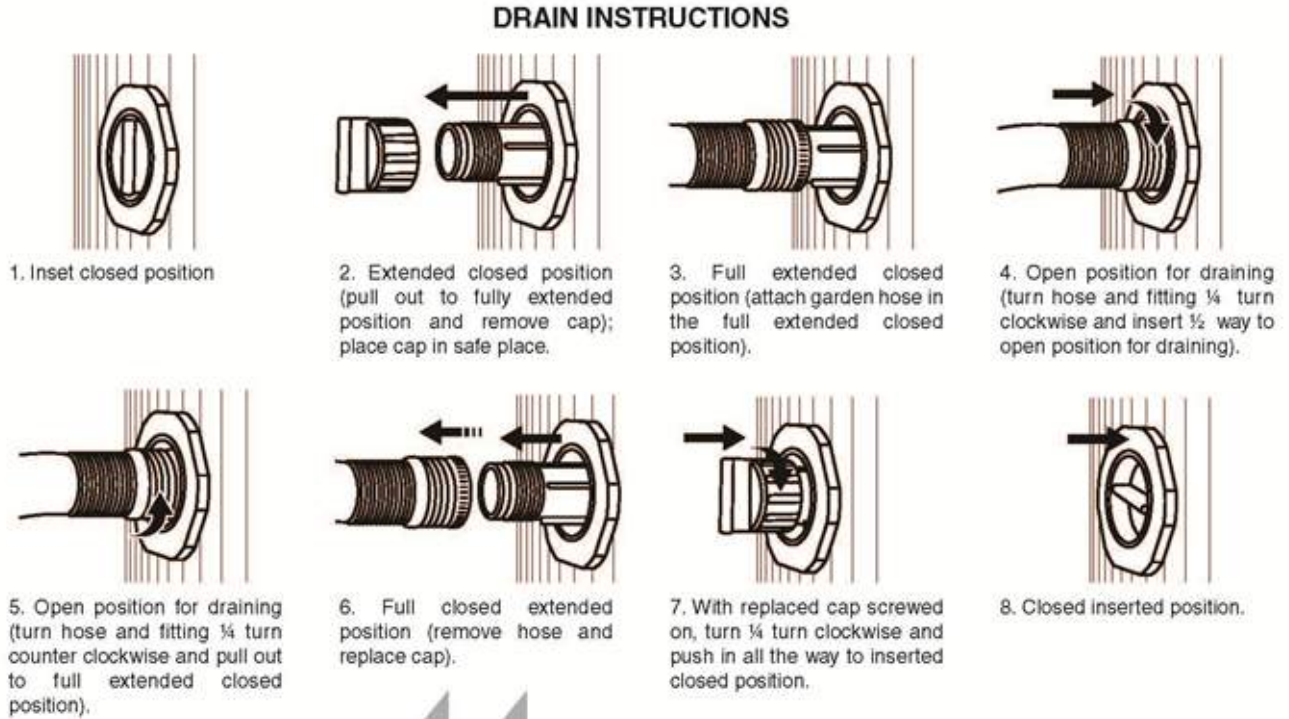

When Vacuuming Spa Lines:

- 1) Vacuum at all suctions in the foot well. This could be 2-6 suction depending on the model.
- 2) Vacuum at the heater input (union and gate valve), usually on the left of the equipment side of the spa.

Make sure to vacuum until you feel no more water coming out, then block the 2 cartridge mounts or block the Elite or Teleweir opening.

Remove the cartridge(s). Thread plugs into the threaded cartridge mounts in the filter box. For Elite or Teleweir filter system, remove the trim ring and weir. Cover the filter opening with rigid plastic and use something with weight to hold it down and vacuum again at the heater input.

This will help draw water out of any lines connected to the spa pack, especially for spas that do not have a circ pump.

WINTERIZING YOUR SPA

Cold climates, where danger of freezing exists, require special care on your part in order to prevent damage to the spa shell and equipment. If you plan to use your spa during the cold months, be sure your pump is running frequently enough to keep the water moving so that the heater will operate. It may be best to set your controls to keep the pump on low speed at all times. This will keep the water from freezing and the heater will come on as the temperatures drop.



WARNING:

If you have a power outage, and cold temperatures are possible, your spa and equipment could freeze, especially if it is mounted in a deck without a cabinet. Ice in the spa and equipment will cause damage.

You should consider the need to have your spa professionally winterized if it is to be dormant for a period. This is especially true if you are taking an extended winter vacation.

Follow the procedure below to help prevent damage to your spa and related equipment:

- 1) Drain the spa of all water, as outlined in owner's manual. Shut off the spa's power supply.
- 2) Remove any remaining water with sponge. If you have a shop vac, try vacuuming as much water as possible out of the jets and spa shell. If you cannot remove all of the water (especially from the air injectors) RV style or plumbing system anti-freeze should be added to the injectors.
- 3) Remove spa equipment system and pump for storage inside. If this is not practical, use the shop vac again to draw any water from the pump(s) casings. Remove lower casing drain plugs. Add anti-freeze to all pump housings. (see note below)

When vacuuming spa lines:

- a) Vacuum at all suctions in the foot well. This could be 2-6 suction depending on the model.
- b) Vacuum at the heater input (union and gate valve), usually on the left of the equipment side of the spa.

Vacuum until you feel no more water coming out, then block the 2 cartridge mounts or block the Elite or Teleweir opening

Remove the cartridge(s). Thread plugs into the threaded cartridge mounts in the filter box. For Elite or Teleweir filter system, remove the Vane weir/trim ring and float assembly. Cover the filter opening with rigid plastic and use something with weight to hold it down. Vacuum again at the heater input.

This will help draw water out of any lines connected to the spa pack, especially for spas that do not have a circ pump.

- 4) The filter should be drained and cartridge removed and cleaned. Remove the filter cartridge and pour anti-freeze as mentioned earlier into the filter canister. Store the filter element in a room with above freezing temperatures.
- 5) Support the hard cover along the hinge with 2 by 4's across the spa. Lock your hard cover over the spa and cover entire spa with a tarpaulin. Block the tarp in place or staple to your cabinetry.
- 6) When you refill in the spring, remember to re-install any plugs that were removed. Follow the directions for start-up, as if this were a new spa.

Note: Any RV style or plumbing system anti-freeze used may leave behind a residue that could cause a white "fizz" in the first refill of water, especially when the jet pump(s) are turned on. You may need to drain and refill the spa to clear away the residue. **During colder months of the year, plumbing anti-freeze is added to all pump housings as part of our production procedures.** This fact is noted on the outer spa packaging.

TROUBLESHOOTING YOUR SPA

COMMON PROBLEMS AND HOW TO SOLVE THEM



NOTICE:

A large number of problems on start-up can be attributed to mis-wiring and a poor understanding of how the spa operates and its' features. Take the time to read and understand this manual. If you have any questions contact your dealer.

Ground Fault Circuit Interrupter (GFCI) or Residual Current Detector (RCD) Shuts Off On Initial Start-Up

Probable cause:	Mis-wiring of GFCI/RCD.
Action:	Contact electrician and/or dealer.

Ground Fault Circuit Interrupter (GFCI) or Residual Current Detector (RCD) Shuts Off (Not on Initial Start-Up)

Probable cause:	One or more pieces of equipment is shorting to ground or total current draw exceeds GFCI/RCD rating.
Action:	Contact dealer: DO NOT use spa. Take measures to ensure others do not use spa.

Spa is Completely “Dead” (No Circulation and No Display on Topside Control Panel)

Probable cause #1:	GFCI/RCD has tripped (shut off).
Action:	Reset GFCI/RCD and monitor for futures trips. Alert dealer if problem persists.

Probable cause #2:	Breaker or fuse before GFCI/RCD is tripped or blown.
Action:	Shut off GFCI/RCD, reset breaker or replace fuse, reset GFCI/RCD and test. Contact electrician or dealer if problem persists.

Probable cause #3:	Transformer fuse blown in spa pack.
Action:	Locate fuse in spa pack, test and/or replace. Or contact dealer for service.

Probable cause #4:	Insufficient line voltage to power up spa pack processor.
Action:	Contact electrician to measure line voltages and inspect supply connections.

No Heat or Heat Too Low

Probable cause #1:	Set point is not at desired level.
Action:	Review set point and change if necessary.

Probable cause #2:	Circ pump is not running or pumping.
Action:	Check if valves on circ pump/heater system are open (handle pulled up exposing valve shaft, safety clips should be in place to prevent valve closure). Check if circ pump is plugged in or if circ pump fuse in spa pack is burnt out.

Probable cause #3:	Spa is not covered when not being used.
Action:	Cover spa to retain heat.

Probable cause #4:	Heater is not on due to error message showing on display.
Action:	Check for open gate valves on equipment, correct low water level in spa, and examine condition of filter cartridge(s). Turn spa power off then back on. Monitor for reoccurring error message on display. Contact dealer if problem persists.

Probable cause #5:	System Input current setting is restricting heater operation.
Action:	Consult dealer/electrician on system current setup and if a higher input current is available from the supply. This may mean rewiring the spa with a larger gauge cable and/or breaker.

Probable cause #6:	Lack of insulation in a custom installation.
Action:	Protect underside of spa from prevailing cold winds or snow. Enclose custom installations.

Jet(s) Do Not Come On When Pump Key is Pressed

Probable cause #1:	Jet pump is not plugged into spa pack.
Action:	Plug pump in and test.
Probable cause #2:	Jet pump fuse blown in spa pack.
Action:	Locate & test/replace pump fuse in spa pack. Contact dealer if problem persists.
Probable cause #3:	Jet pump is not primed.
Action:	Shut off spa and allow trapped air to escape. Restart spa & check jet pump operation. If problem persists bleed air at pump directly by opening union on pump until all entrapped air is released. Retest.
Probable cause #4:	Individually adjustable volume jets are adjusted to low volume.
Action:	Turn face of specific jet to increase water volume.
Probable cause #5:	Air control is closed. No visible air/water mix.
Action:	Open air control to increase air/water mix.
Probable cause #6:	Pump has overheated and tripped internal thermal overload.
Action:	Wait for pump to cool & listen for "snap" sound as overload resets. Pump should restart. Contact dealer if problem persists.
Probable cause #7:	Pump is not pumping due to broken part inside (motor works, pump is primed but there is no water movement from pump).
Action:	Contact dealer for service.

LED Light(s) Do Not Come On When Light Key is Pressed

Probable cause #1:	Light fuse blown in spa pack
Action:	Locate and test/replace light fuse in spa pack Call dealer if problem persists.

Probable cause #2:	In -line or on board fuse blown in LED controller
Action:	Locate and test/replace light fuse in LED control box.

No Air/Water Mixture Coming From a Jet

Probable cause #1:	Air control is closed
Action:	Open air control

Probable cause #2:	Water volume through jet is too low to draw air
Action:	Increase water volume by turning jet face

Probable cause #3:	Adjustable jet internal is loose.
Action:	Tighten jet internal

Probable cause #4:	Jet internal is broken or damaged
Action:	Replace jet internal with another one from the spa or with a new one.

Probable cause #5:	Debris inside the jet internal
Action:	Remove the internal, inspect for debris, remove debris and re-install. Test

HOW TO CHECK A FUSE

Note: You should only remove/check a fuse if you feel comfortable doing so. **Do not risk personal injury. If in doubt, contact your service technician.**

Fuses are located within the wiring compartment. Always replace fuses with the same style and amp value as shown on the label inside the wiring compartment!

Small Glass Fuses

- 1) Shut off power to the spa.
- 2) Use a small screwdriver or pliers to gently remove the fuse from its fuse holder.
- 3) View the filament inside the fuse and replace if broken.
- 4) Use an ohmmeter to check the fuse. Ohms reading should be towards 0 ohms. A reading of infinity means the fuse is open and must be replaced.

Cartridge Fuses & Small Cartridge Fuses

- 1) Shut off power to the spa.
- 2) Use pliers to remove the fuse from its fuse holder.
- 3) Replace fuse and test system.

These types of fuses are available from your local dealer and may be available from local electronic stores and home centres. Each fuse has a voltage and amp rating listed on it and should be used to obtain a replacement fuse.

Note: A single fuse may protect more than 1 component in your spa.

WARRANTY SERVICE

In the event that you require warranty service, please call the authorized dealer where you purchased the spa. Your dealer has trained service personnel and an obligation to provide you with excellent after-sales service. We conduct yearly training classes to update and refresh technicians.

CONFIRMING A SERVICE APPOINTMENT

Have ready the serial number and model number/name of your spa, your date of purchase and store receipt. The spa model and serial number information can be found on the silver and black data plate attached to the lower right corner on the equipment side of the spa. It is also located on the Spa Identification Sheet that is within a plastic bag stapled to the backside of the equipment panel.

BP601X SERIES SPA PACKS

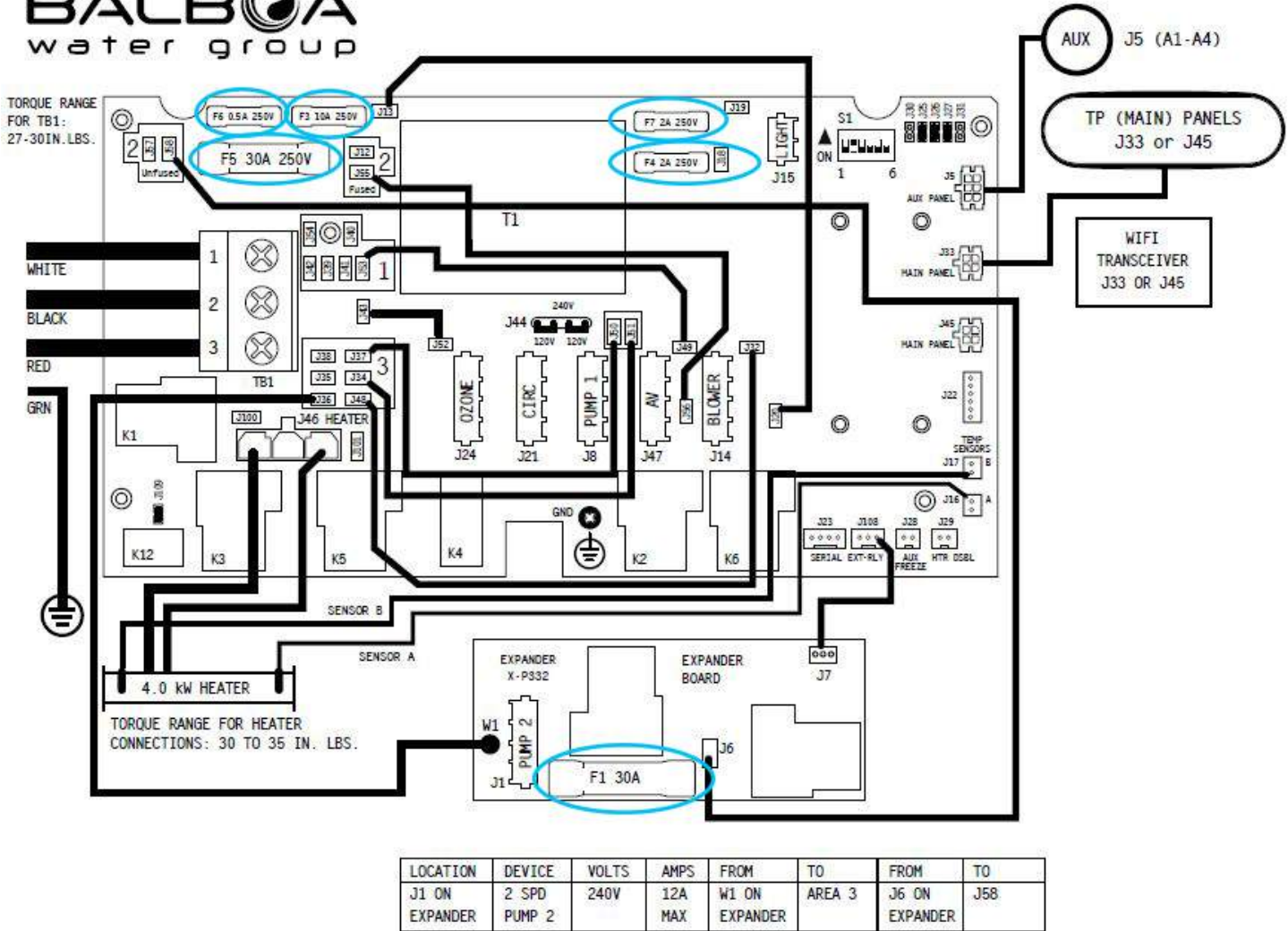

“Typical Board Layout”

Fuse	Size	Protects
F1	30A, 250V	Pump 2 (Expanded Board)
F3	10A, 250V	Blower
F4	2A, 250V	Spa Light
F5	30A	Pump 1, Circ Pump, Ozone
F6	0.5A, 250V	Transformer Input
F7	2A, 250V	Transformer Input

BP501 SERIES SPA PACKS

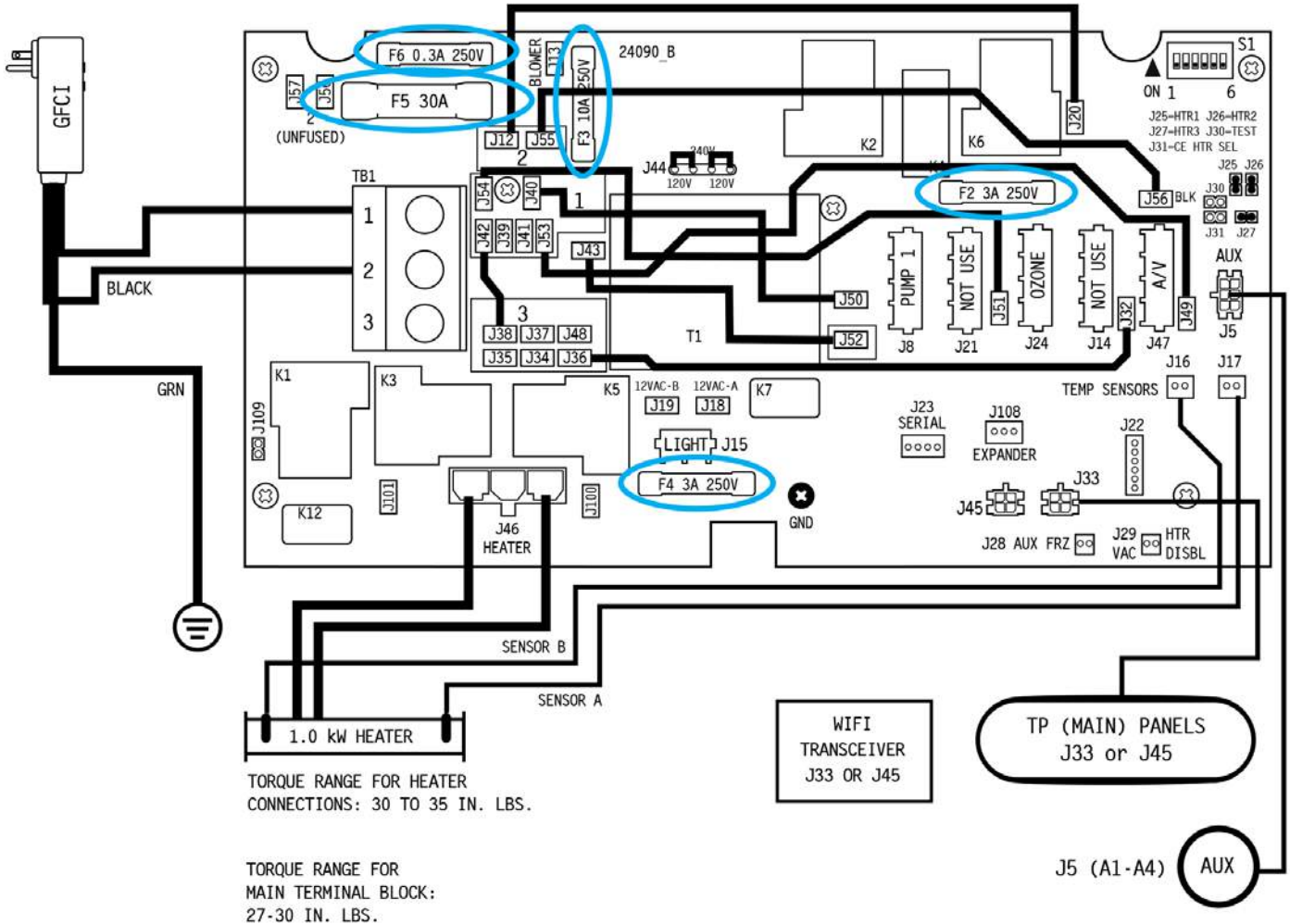

"Typical Board Layout"

Fuse	Size	Protects
F3	10A, 250V	Blower
F4	2A, 250V	Spa Light
F5	30A	Pump 1, Circ Pump, Ozone
F6	0.5A, 250V	Transformer Input
F7	2A, 250V	Transformer Input

BP501X SERIES SPA PACKS

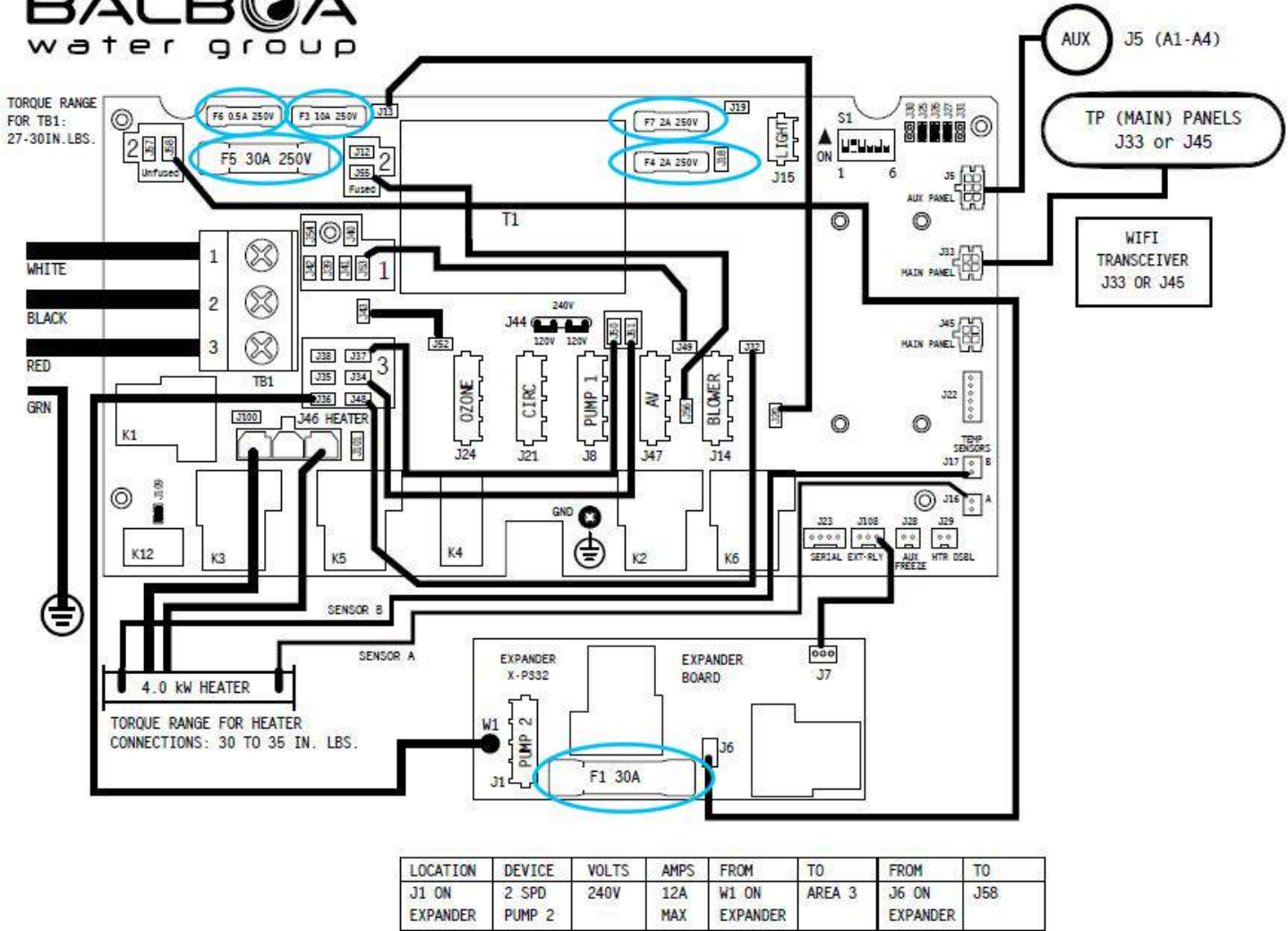

“Typical Board Layout”

Fuse	Size	Protects
F1	30A, 250V	Pump 2 (Expanded Board)
F3	10A, 250V	Blower
F4	2A, 250V	Spa Light
F5	30A	Pump 1, Circ Pump, Ozone
F6	0.5A, 250V	Transformer Input
F7	2A, 250V	Transformer Input

BP2000/2100 SERIES SPA PACKS

Includes: SRBP21X

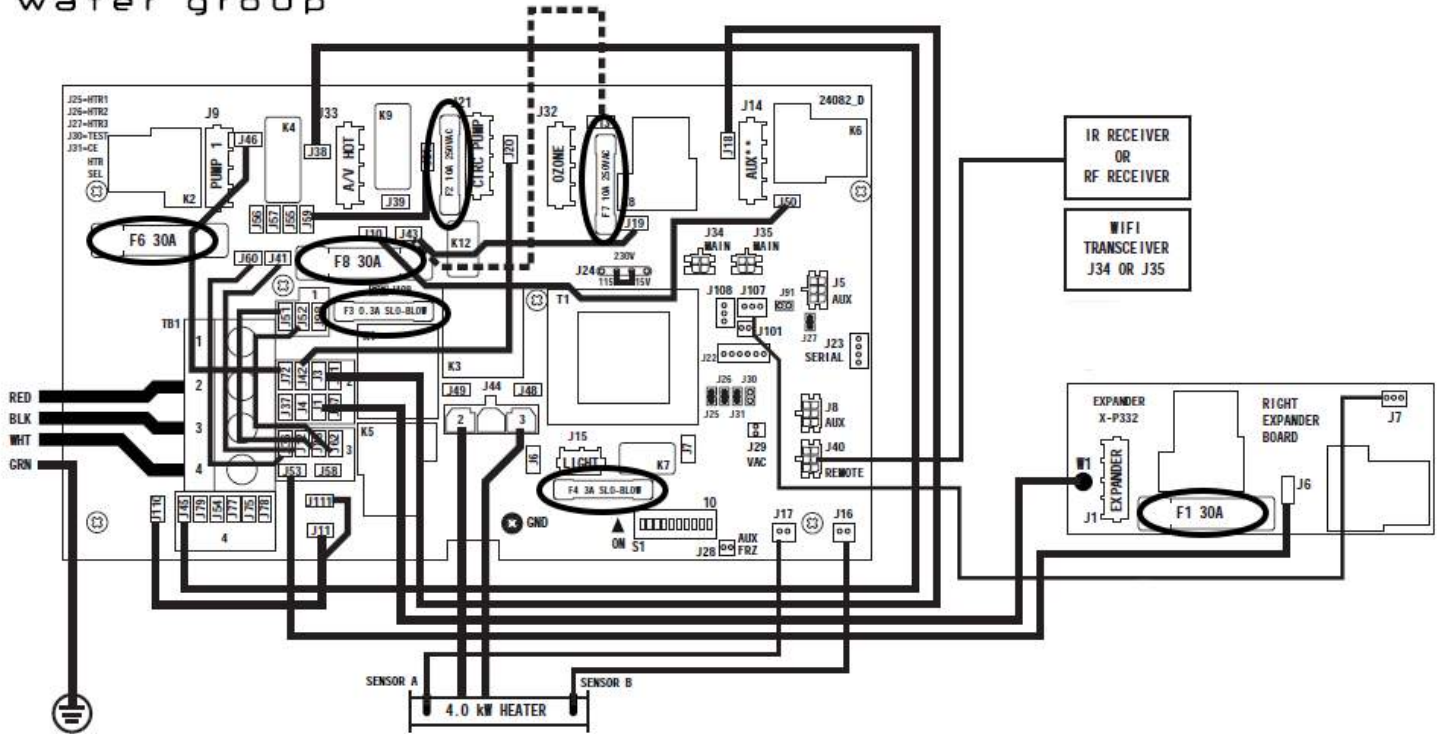

“Typical Board Layout”

Fuse	Size	Protects
F1	30A	Component(s) plugged into J1 on expander board Typically Pump 2, Pump 3, Microsilik
F2	10A, 250VAC	Ozonator, Circ Pump
F3	0.3A, S10-B10	Transformer
F4	3A, S10-B10	Spa light
F6	30A	Pump 1, Audio
F7	10A, 250V	Blower (J14)
F8	30A	Pump 2, Blower (J14)

Note: When system software set-up is such that blower is connected to Expander X-P332, the inline fuse in the AMP adapter is 10A, 250V.

WATER TREATMENT GUIDE



HEALTH HAZARD:

The water in your spa must be chemically treated and maintained at regular intervals.

Bacteria can enter your spa water through the fill source, the bathers, and the environment. It is the responsibility of the spa owner to chemically treat the spa water in accordance with the local standards. Cross contamination between bathers can occur.

Your dealer or local pool and spa professional can provide expert testing along with all the products you will need for clear, clean, healthy spa water. Follow their instructions.

Untreated water is not only uncomfortable to relax in; it poses a health hazard to all bathers and a safety hazard to the equipment.

Equipment and surface damage caused by poor water treatment and/or unbalanced spa water is not covered under warranty.

SANITIZING YOUR SPA

IMPORTANT: * Your dealer may be promoting a water treatment system that does not employ part of all of the general water care instructions below. This guide is designed to give the spa owner a basic understanding of spa water treatment.* When in doubt, follow the recommendations of your dealer. It is recommended that you have your source water tested by your dealer or local testing agency before the first fill. Knowing the characteristics of your source water can help you maintain clean and clear spa water on a regular basis.

Do not allow any floating chemical dispenser to get drawn in and held in the skimming area. Large amounts of chemical can become concentrated in one area and damage the acrylic surface. This type of damage is not covered under the warranty.

Initial Start-Up

(Review chemical manual - if applicable)

Your spa has _____ litres, _____ gallons of water (please fill in).

- 1) When the spa is full, add a scale preventative to inhibit staining and scale formation.
- 2) Test and adjust alkalinity to level recommended by manufacturer, this stabilizes pH.
- 3) Circulate water for 24 hours.
- 4) Test the pH. The ideal range is 7.2 to 7.6. Adjust if necessary with pH Booster or pH Reducer.
- 5) Circulate the water for 30 minutes.
- 6) If you are using Organic Bromine (Bromine Tablets), adjust your dispenser so the bromine residual is 3 to 5 ppm. Lower bromine level may be possible with ozonator.
- 7) Whenever adjusting spa chemicals, less is better. Add chemicals in small amounts over several days.

Does your spa have a Fresh Water Ozone system on it?

- 1) The Fresh Water Ozone System is very simple to monitor. Follow the procedures listed below to ensure continued clean, healthy water.
- 2) Using chlorine and a DPD test kit, measure Free Available Chlorine (FAC) and Total Chlorine (TC). As long as the difference is less than 0.5 ppm, the powerful oxidizer from the Fresh Water Ozone system is entering your spa and cleaning your water. You will only need to add small amounts of chlorine to maintain a sanitizer.
- 3) Check your pH, total alkalinity and calcium hardness as recommended by your Sunrise Spa dealer, and adjust if required. Please note: With the Sunrise Fresh Water Ozone system, maintain a pH between 7.6 and 7.8.
- 4) Check the bubble mist entering the spa, via the dedicated ozone/return jet, for consistency. An irregular bubble mist could indicate a blockage in the pump or pipes, a dirty cartridge(s) , low water level or pump operation problems.
- 5) On an ultraviolet ozonator, check the glow fitting on the ozonator for a blue colour to ensure that the bulb is on. On a CD ozonator check that the 'power on' indicator light is on.
- 6) Disconnect the tubing from the glow fitting and place your finger over the end of the tubing to feel for suction. This will ensure that the bubble mist entering your spa is coming through the Sunrise Fresh Water Ozone system.

REMEMBER: Your spa water cannot be treated if the circulation system is not operating. The longer the spa's circulation system runs, the cleaner your water will be. This is not a problem on spa with a dedicated circulation pump. However, on models that use the low speed of a 2-speed pump to circulate the water, the filter cycle should be no less than 4 to 6 hours per day.



Daily Maintenance

To keep your spa water sparkling clear and odour free, follow these steps:

- 1) Spas with adjustable filter cycles should be operated a minimum of 8 hours a day to remove suspended particles that may exist.(4 hours per a 12 hour period)
- 2) Test pH to maintain a level of 7.2 to 7.6. If an ozonator is being used, pH should be 7.8 while ozonator is working.
- 3) If you are using Organic Bromine (Bromine Tablets) adjust your feeder so the bromine residual is 3 to 5 ppm.

Weekly Maintenance

When the spa is not in use:

- 1) Add 1 cap (30 mL) of a Scale Preventative per 250 gal (1000 Litres) to inhibit scaling and staining. Circulate water for 30 minutes.
- 2) Add a Brightener 24 hours after adding the Scale Preventative. Circulate the water for 30 minutes.
- 3) With the bromine sanitizing system, contaminants may build up during the week. The spa should be shocked with a Spa Shock. This will eliminate any odour and restore clarity to the water.

Periodic Maintenance

- 1) Greases, oils and organic waste can accumulate on the filter cartridge reducing their efficiency and limiting the effectiveness of the disinfectant. Clean the filter with CARTRIDGE CLEANER as directed. Physically clean the filter basket daily (if applicable).

NOTE: It is not recommended to use muriatic acid on filter cartridges as this is a raw chemical which does not rinse out well, ending up back in the water causing low pH levels.

- 2) The use of the scum ball will cut down on grease, foam and suspended particles in the spa. The scum ball acts as a filter before the filter and will increase the life of the cartridge.
- 3) The use of a thermal insulated hard cover will reduce evaporation and heat loss. Keep cover on and level at all times when spa is not in use.
- 4) Once you have established a comfortable water temperature to soak at, leave the thermostat at that temperature. Rapid changes in water temperature consume more energy.
- 5) Take a sample of water to your dealer to test for alkalinity, calcium and total dissolved solids.
- 6) WHEN TO DRAIN SPA WATER. Due to the warm water temperature and high evaporation rate, the total dissolved solids tend to build up. For this reason we recommend draining and refilling the spa every 2 to 4 months - depending on usage.
- 7) Clean your filter(s) at least once every two weeks or after heavy bather loads, by soaking your filter(s) in cartridge cleaner. Dirty filters cause the heater to shut off or the spa temperature to drift lower than desired.

NOTE: Remove any objects floating on the water before removing skimmer basket and filter or they may be sucked into the pump.

NOTE: Spas should not be left running unattended without filters. Remove filters for cleaning. Always turn off the spa before removing the cartridge(s) Debris can enter plumbing and cause damage.

CHEMICAL SAFETY TIPS

Read the Directions Carefully

- 1) Always add chemicals to water, never add water to chemicals.
- 2) Do not mix chemicals.
- 3) Store chemicals in a cool dry place - out of reach of children.
- 4) In case of contact or if chemical is swallowed, follow emergency advice on product label.
- 5) Do not smoke near chemicals. Keep the container closed when not in use.

Water Balance

Water balance is important to the overall performance of your spa. No 2 spa's water conditions are exactly alike. The water source, location of the spa and frequency of use all effect the water balance. Unbalanced water can damage the equipment, especially the heater element, make the water uncomfortable for the user, and decrease the effectiveness of the disinfectant. Total alkalinity, pH, and calcium hardness must be within the correct range to balance the water. Damage to equipment caused by improper water chemistry is not covered by warranty.

pH

Simply pH is a scale indicating whether spa water is basic, neutral or acidic. Spa water should be slightly basic 7.2 to 7.6; 7.8 with an ozonator in operation. A low pH below 7.2 leads to corrosion of spa equipment and will irritate the skin of the bathers. The sanitizer will dissipate more rapidly. A low pH can be corrected by adding a pH Increaser.

Alkalinity

Total alkalinity is a measure of the alkaline in the water. They act as a pH buffer or a pH stabilizer preventing large changes in the pH. The total alkalinity should be between 80 to 150 ppm; ideally 120 ppm. Tablet chlorine and bromine tend to gradually lower the alkalinity level.

Low total alkalinity causes:

- the pH to wander
- corrosive water
- disinfectants to be ineffective

To raise the total alkalinity, add ALKA RISE.

High total alkalinity causes:

- cloudy water
- scale formation

To lower the total alkalinity, add a pH Reducer.

Calcium Hardness

Calcium hardness is the hardness present due to dissolved calcium. The desired range is 150 ppm to 280 ppm.

Low calcium hardness causes:

- corrosive water
- staining of spa

To correct this problem, add a Scale Preventative. (Do not fill the spa with soft water!)

Common Spa Water Problems

PROBLEM	POSSIBLE CAUSE	SOLUTION
CLOUDY WATER	<ul style="list-style-type: none"> a) Organic contaminants build up b) Suspended particles c) pH high d) Total Alkalinity too high e) Hardness too high f) Poor filtration g) High dissolved solids 	<ul style="list-style-type: none"> a) Shock treatment with a Spa Shock b) Add a Brightener, use scum ball c) Add pH reducer, until pH level reads 7.2 - 7.6 d) Add pH reducer, adjust total alkalinity to 80-150ppm e) Add a Scale Preventative, circulate through a water softener until hardness is 150-280ppm. f) Dirty filter, clean with Cartridge Cleaner g) Empty spa and refill
COLOURED WATER	<ul style="list-style-type: none"> a) Dissolved copper, iron and other metals from source water or equipment b) Algae c) Fragrance 	<ul style="list-style-type: none"> a) Use Scale Preventative, have your dealer check water balance b) Add an Algaecide c) Stop the use of fragrance
FOAMING	<ul style="list-style-type: none"> a) High concentration of oils and organic contaminants being agitated by jets b) Soft water 	<ul style="list-style-type: none"> a) Squirt Defoamer on foam; use the scum ball or spa ball b) Add a Calcium Increaser until hardness is 150-280ppm.
SCALE DEPOSITS	High calcium level, high pH, high alkalinity	Drain partially, add a Scale Preventative to correct pH level to 7.2 - 7.6 and alkalinity to 80-150ppm.
ODOUR	High level of organic contaminants, combined bromine	Shock with a Spa Shock
EYE/SKIN IRRITATION	pH too low	Add a pH Booster until level is 7.2 - 7.6
NO BROMINE READING	High concentration of organic contaminants using up sanitizers	Add sanitizers (bromine) until levels are up to recommended range



www.sunrisespas.com