

# Dell PowerEdge RAID Controller S150

## User's Guide

## Notes, cautions, and warnings

 **NOTE:** A NOTE indicates important information that helps you make better use of your product.

 **CAUTION:** A CAUTION indicates either potential damage to hardware or loss of data and tells you how to avoid the problem.

 **WARNING:** A WARNING indicates a potential for property damage, personal injury, or death.

<b>Chapter 1: Overview.....</b>	<b>6</b>
PERC S150 specifications.....	6
Supported operating systems.....	9
Supported PowerEdge systems.....	9
Supported physical disks.....	10
Management applications for the PERC S150.....	10
<b>Chapter 2: Physical Disks.....</b>	<b>11</b>
Physical disk features.....	11
Physical disk roaming.....	11
Physical disk hot-swapping.....	11
Physical disk power management.....	11
Physical disk failure detection.....	11
Mirror rebuilding.....	12
Fault tolerance.....	12
Self-monitoring and reporting technology.....	12
Native Command Queuing.....	12
NVMe PCIe SSD support.....	12
Physical disk write cache policy for SATA drives.....	13
Linux RAID.....	14
<b>Chapter 3: Virtual Disks.....</b>	<b>15</b>
Virtual disk features.....	15
TRIM for SATA SSDs.....	15
Disk initialization.....	16
Background Array Scan.....	16
Checkpointing.....	16
Consistency check.....	16
Background initialization.....	16
Automatic virtual disk rebuild.....	17
Virtual disk cache policies.....	17
Virtual disk migration.....	17
Migrating a virtual disk.....	17
Expanding virtual disk capacity.....	18
<b>Chapter 4: Cabling the drives for the S150.....</b>	<b>19</b>
Disk connectivity for AHCI devices.....	21
<b>Chapter 5: BIOS Configuration Utility.....</b>	<b>23</b>
Entering the BIOS configuration utility.....	23
Exiting the BIOS Configuration Utility.....	24
Initializing the physical disks.....	24
Converting to RAID disks.....	24
Converting to Non-RAID disks.....	24

Creating the virtual disks.....	25
Selecting virtual disk sizes while creating a virtual disk .....	25
Deleting the virtual disks.....	25
Swapping two virtual disks.....	26
Managing the hot spare disks.....	26
Assigning the global hot spare disks.....	26
Unassign hot spare disks.....	26
Viewing the physical disks details.....	27
Viewing the virtual disks details.....	27
Rescan disks.....	27
Controller Options.....	27
Continue to boot.....	28
<b>Chapter 6: UEFI RAID configuration utility.....</b>	<b>29</b>
Entering the DELL PERC S150 Configuration Utility.....	29
Exiting the DELL PERC S150 Configuration Utility.....	29
Controller management.....	30
Virtual disk management.....	31
Physical disk management.....	35
<b>Chapter 7: Installing the drivers.....</b>	<b>39</b>
Pre-installation requirements.....	39
Setting the SATA controller to RAID mode .....	39
Setting the NVMe PCIe SSDs to RAID mode .....	39
Creating a virtual disk.....	40
Checking PERC S150 options and the boot list priority.....	40
Creating the device driver media for Windows driver installation.....	41
Downloading drivers for PERC S150 from the Dell support website for all operating systems.....	41
Downloading drivers from the Dell Systems Service and Diagnostic Tools media for Windows.....	41
Accessing ZP files.....	42
<b>Chapter 8: Troubleshooting your system.....</b>	<b>43</b>
Precautions for hot removal or hot insertion of NVMe drives.....	43
Unable to configure Linux RAID using UEFI Configuration Utility.....	43
Performance degradation after disabling SATA physical disk write cache policy.....	44
Unable to modify any feature settings in UEFI or OPR0M.....	44
Extra reboot during OS installation.....	44
OS installation failing on NVMe PCIe SSD with third-party driver.....	44
Server performance is slow and crashes during OS installation on the SATA configuration .....	44
Server performance is slow during OS installation on the NVMe configuration .....	45
System startup issues.....	45
System does not boot.....	45
Controller mode is set incorrectly at system setup.....	45
Boot mode, boot sequence, and or boot sequence retry are set incorrectly .....	45
Bootable virtual disk is in a failed state .....	46
The boot order is incorrect for a bootable virtual disk .....	46
A Non-RAID virtual disk is no longer in first position in the BIOS configuration utility list after a system reboot .....	46
The BIOS configuration utility option does not display .....	46

Configuring RAID using the ROM utility option is disabled.....	46
Warning Messages.....	46
WARNING- Found virtual disks that are degraded .....	47
WARNING - Found virtual disks that are failed .....	47
WARNING - Found virtual disks that are degraded and failed .....	47
Other errors appearing on the BIOS screen.....	48
BSOD is observed while booting on the NVMe configuration server.....	48
S150 controller lists M.2 drives.....	48
Error in displaying the CD/DVD-ROM while in legacy mode.....	48
Unavailable error under UEFI boot settings.....	48
S150 does not display greater than ten virtual disks in the BIOS Configuration Utility or CTRL R .....	48
Unable to delete virtual disks when there are more than 30 virtual disks present in the system.....	48
Virtual disk rebuild status in the BIOS Configuration Utility (<CTRL><R>) or in UEFI HII.....	49
Physical disk - related errors.....	49
The physical disk fails.....	49
Cannot initialize a physical disk .....	49
Status LED is not working.....	50
Behavior of a faulty drive is undefined.....	50
Cannot update NVMe PCIe SSD firmware by using Dell Update Package or DUP.....	50
NVMe drive error when inserted for the first time.....	50
Third-party driver installation for NVMe PCIe SSD failing.....	50
Unable to find the NVMe PCIe SSD for operating system installation.....	50
Virtual disks - related errors.....	50
Stale partitions are listed on creating a virtual disk for Linux.....	51
Rebuilding a virtual disk the global hot spare is not listed as online in HII or iDRAC.....	51
S150 displays 22 virtual disks on POST instead of 30 virtual disks.....	51
S150 displays 43 virtual disks on POST instead of 30 virtual disks.....	51
Display of failed virtual disk in HII.....	52
Virtual disk size in decimals is not supported while creating a VD.....	52
Cannot create a virtual disk.....	52
A virtual disk is in a degraded state.....	53
Cannot assign a dedicated hot spare to a virtual disk.....	54
Cannot create a global hot spare .....	54
A dedicated hot spare fails.....	55
Failed or degraded virtual disk .....	55
Cannot create a virtual disk on selected physical disks .....	55
RAID disk created from the NVMe PCIe SSDs not appearing in operating system environment, showing as partitioned disks .....	56
Cannot perform an online capacity expansion or reconfigure on a virtual disk .....	56
Unable to configure RAID on NVMe PCIe SSD using a third party RAID configuration utility .....	56
S150 config driver is not installed after S150 DUP is run.....	56
S150 driver not identifying P4800 drives.....	56
S150 DUP update message is displayed only for SATA controllers .....	56
<b>Chapter 9: Getting help.....</b>	<b>57</b>
Recycling or End-of-Life service information.....	57
Contacting Dell.....	57
<b>Chapter 10: Documentation resources.....</b>	<b>58</b>

# Overview

The Dell PowerEdge RAID Controller (PERC) S150 is a Software RAID solution for the Dell PowerEdge systems. The S150 controller supports up to 30 Non-Volatile Memory express (NVMe) PCIe SSDs, SATA SSDs, SATA HDDs depending on your system backplane configuration.

## Topics:

- [PERC S150 specifications](#)
- [Supported operating systems](#)
- [Supported PowerEdge systems](#)
- [Supported physical disks](#)
- [Management applications for the PERC S150](#)

## PERC S150 specifications

The following table provides PERC S150 specifications for SATA and NVMe PCIe SSDs:

 **NOTE:** Specifications vary depending on the system model.

 **CAUTION:** Not adhering to specifications regarding maximum and minimum virtual disks or physical disks will lead to undefined behavior.

**Table 1. Specifications for PERC S150**

Specification	PERC S150
SATA SSD technology	Yes
NVMe support	Yes
SAS connectors	No
Dell-compliant SAS compatibility	No
Direct-connected end devices	Dell-compliant HDDs, SSDs, and SATA DVDs
SMART error support through management applications	Yes
Backplane supported systems	Yes
Support for internal tape drive	No
Support for global hot spare	Yes
Support for 512 native and 512e drives	Yes
Support for 4Kn native drives	No
Maximum number of global hot spares	Varies with the number of free disks in the system
Maximum number of physical disks supported (SATA + NVMe)	30
Minimum RAM size required	16 GB

**Table 2. SATA specifications for PERC S150**

Specification	PERC S150
Dell-compliant SATA compatibility	Yes
Communication with the end devices	SATA links

**Table 2. SATA specifications for PERC S150 (continued)**

Specification	PERC S150
SATA connectors	Discrete on the system board
I/O controller	Advanced Micro Devices (AMD)
Communication with the system	Integrated
Software-based RAID for SATA drives	Windows RAID: Volume, RAID 0, RAID 1, RAID 5 and RAID 10
	Linux RAID: RAID 1
<b>i NOTE:</b> After the operating system is installed on a RAID 1 disk, you can create non-boot virtual disks of any RAID level supported by the installed Linux operating system using native Linux RAID utilities.	
Pass-through SSD support	Yes
<b>i NOTE:</b> SATA BAY ID always displays as 1 in S150 UEFI HII.	

**Table 3. NVMe specifications for PERC S150**

Specification	PERC S150
<b>i NOTE:</b> On systems running Windows, if there is no NSID=1 present on the NVMe drive, the drive is not accessible and is marked offline. Firmware upgrades run on the NVMe drive are successful, however.	
NVMe connectors	PCIe/slimline
<b>i NOTE:</b> Only Dell-compliant NVMe PCIe SSD 2.5-inch small form factor (SFF), or NVMe PCIe SSD adapter cards are supported.	
Dell-compliant NVMe compatibility	Yes
Communication with end devices	PCIe
Software-based RAID for NVMe PCIe SSDs	Windows RAID: Volume, RAID 0, RAID 1, RAID 5, and RAID 10
	Linux RAID: RAID 1
<b>i NOTE:</b> After the operating system is installed on a RAID 1 disk, you can create non-boot virtual disks of any RAID level supported by the installed Linux operating system using native Linux RAID utilities.	
Pass-through NVMe PCIe SSD support	Yes
<b>i NOTE:</b> Installation of OS on Volume VD through LC UI is not supported.	

The following table provides PERC S150 virtual disk specifications:

**Table 4. Virtual disk specifications for PERC S150 with SATA configuration**

Specification	PERC S150
Maximum number of physical disks supported	8
Maximum number of virtual disks supported	30
<b>i NOTE:</b> The maximum number of virtual disks may exceed 30 when physical disks are migrated from any other configuration or a disk in Ready state is converted to a non-RAID disk.	
Maximum number of virtual disks supported from a single disk group	8
<b>i NOTE:</b> Maximum number of virtual disks can exceed more than 8 from a single disk group as there is no constraint from PERC S150.	
Minimum virtual disk (VD) size	10 GB

**Table 4. Virtual disk specifications for PERC S150 with SATA configuration (continued)**

Specification	PERC S150
<b>i</b> <b>NOTE:</b> PERC S150 does not restrict the creation of VDs of size less than 10 GB.	
Maximum number of physical disks per virtual disk	8
<b>i</b> <b>NOTE:</b> PERC S150 does not restrict the creation of VDs using more than 8 physical disks.	
Maximum number of virtual disks per physical disk	8
Maximum number of physical disks in a volume	1
Maximum number of physical disks in a RAID 0	8
Maximum number of physical disks in a RAID 1	2
Maximum number of physical disks in a RAID 5	8
Maximum number of physical disks in a RAID 10	8
Minimum number of physical disks in a volume	1
Minimum number of physical disks in a RAID 0	2
Minimum number of physical disks in a RAID 1	2
Minimum number of physical disks in a RAID 5	3
Minimum number of physical disks in a RAID 10	4

**i** **NOTE:** The configurations that are listed in the table above may vary with the hard-drive backplane of your system.

**Table 5. Virtual disk specifications for PERC S150 with NVMe configuration**

Specification	PERC S150
Maximum number of physical disks supported	30
Maximum number of virtual disks supported	30
<b>i</b> <b>NOTE:</b> The maximum number of virtual disks may exceed 30 when physical disks are migrated from any other configuration or a disk in Ready state is converted to a non-RAID disk.	
Maximum number of virtual disks supported from a single disk group	8
<b>i</b> <b>NOTE:</b> Maximum number of virtual disks can exceed more than 8 from a single disk group as there is no constraint from PERC S150.	
Minimum virtual disk (VD) size	10 GB
<b>i</b> <b>NOTE:</b> PERC S150 does not restrict the creation of VDs of size less than 10 GB.	
Maximum number of physical disks per virtual disk	8
<b>i</b> <b>NOTE:</b> PERC S150 does not restrict the creation of VDs using more than 8 physical disks. Not adhering to the VD specification will lead to undefined behavior.	
Maximum number of virtual disks per physical disk	8
Maximum number of physical disks in a volume	1
Maximum number of physical disks in a RAID 0	8
Maximum number of physical disks in a RAID 1	2
Maximum number of physical disks in a RAID 5	8
Maximum number of physical disks in a RAID 10	8



**Table 5. Virtual disk specifications for PERC S150 with NVMe configuration (continued)**

Specification	PERC S150
Minimum number of physical disks in a volume	1
Minimum number of physical disks in a RAID 0	2
Minimum number of physical disks in a RAID 1	2
Minimum number of physical disks in a RAID 5	3
Minimum number of physical disks in a RAID 10	4

## Supported operating systems

The S150 controller supports the following operating systems:

**i** **NOTE:** It is highly recommended to see the [Dell Enterprise operating systems support](#) section to view the details of the operating systems supported by specific servers.

- Microsoft
  - Windows Server 2025
  - Windows Server 2022
  - Windows Server 2019
- See [Linux RAID](#) for capabilities when using the following Linux operating systems:
  - Red Hat Enterprise Linux 9.0 and later versions
  - SUSE Linux Enterprise Server version 15 SP1 and later versions

**i** **NOTE:** The S150 supports Linux only for prebooting the configuration utility capability for enabling the Linux MDRAID. For more information, see [Linux RAID](#).

**i** **NOTE:** Kickstart installs are supported only on RHEL 8.2+.

**i** **NOTE:** For the latest list of supported operating systems and driver installation instructions, see the system documentation at [Operating Systems Manuals](#). For specific operating system service pack requirements, see the Drivers and Downloads section at [Supported Drivers](#).

## Supported PowerEdge systems

The following PowerEdge systems support the S150 controller:

- PowerEdge R6515
- PowerEdge R7515
- PowerEdge R6525
- PowerEdge R7525
- PowerEdge C6525
- PowerEdge R650
- PowerEdge R650 XS
- PowerEdge R750
- PowerEdge R750 XS
- PowerEdge R750 XA
- PowerEdge MX750C
- PowerEdge C6520
- PowerEdge R450
- PowerEdge R550
- PowerEdge XR11
- PowerEdge XR12
- PowerEdge XE8545
- PowerEdge T150

- PowerEdge T350
- PowerEdge R250
- PowerEdge R350
- PowerEdge T550

## Supported physical disks

The PERC S150 controller supports the following physical disk types:

- SATA hard disk drives (HDDs)
- SATA solid state drives (SSDs), with the exception of the M.2 SATA form factor, which is not supported. Mixing drives of different speeds (rpm) and bandwidths (Gbps) while maintaining the same drive type (SATA) and technology (HDD or SSD) is supported.
- NVMe PCIe SSDs

Only Dell-compliant NVMe PCIe SSDs are supported. Some non-Dell-certified NVMe drives can be used, although they are unsupported, including Micron device IDs 0x5190 and 0x5192, Western digital device ID 0x0023, Samsung device ID 0XA808, and Intel device IDs 0x0A54 and 0x2701. Mixing NVMe PCIe SSDs and SATA drives is not supported in a single RAID virtual disk. For information on PowerEdge NVMe 2.5-inch SFF and PowerEdge NVMe PCIe SSD adapter, see the Express Flash NVMe PCIe SSD user's guide at [Dell.com/manuals](http://Dell.com/manuals).

## Management applications for the PERC S150

Management applications are used to manage and configure the RAID subsystem, create and manage multiple disk groups, control and monitor multiple RAID systems, and provide online maintenance. Management applications for PERC S150 include:

- BIOS Configuration Utility—This storage management application is also known as Ctrl+R, and it configures and maintains RAID disk groups and virtual disks. See [The BIOS configuration utility option does not display](#) .
- Unified Extensible Firmware Interface (UEFI) RAID Configuration Utility—This storage management application is integrated into the System BIOS, accessible through the F2 key. See [The BIOS configuration utility option does not display](#) . RAID configurations on NVMe PCIe SSDs are only supported through the UEFI RAID configuration utility.

 **NOTE:** Ensure that the RAID mode is enabled for NVMe PCIe SSDs. See [Setting the NVMe PCIe SSDs to RAID mode](#) .

- OpenManage Storage Management—This application is used to perform controller and enclosure functions for all supported RAID controllers and enclosures from a single graphical or command-line interface without using controller BIOS utilities. For more information, see the *OpenManage Storage Management User's Guide* at [OpenManage Documentation](#).
- Lifecycle Controller—This is a management application for PERC. For more information, see the [iDRAC Documentation](#).
- iDRAC—For information about the features supported in iDRAC, see the iDRAC Users Guide at [iDRAC Documentation](#).
- iDRAC Service Module (iSM)—A CLI based application that can be used to perform controller and enclosure related functions on all supported RAID controllers. For more information, see the iDRAC Service Module documentation on the support site.

# Physical Disks

**NOTE:** The physical disks in a virtual disk must be of the same drive type (HDD, SSD or NVMe PCIe SSD). For example, you cannot mix an HDD and an NVMe PCIe SSD in the same virtual disk.

**NOTE:** The drive activity LED blinks continuously while there are background tasks running on the disk.

## Topics:

- Physical disk features

## Physical disk features

### Physical disk roaming

Physical disk roaming is moving the physical disks from one cable connection or backplane slot to another on the same controller. The controller automatically recognizes the relocated physical disks and logically places them in the virtual disks, which are part of the disk group. You can perform disk roaming only when the system is turned off.

**CAUTION:** Do not attempt disk roaming during online capacity expansion (OCE). This causes loss of the virtual disk.

### Physical disk hot-swapping

**NOTE:** To check if the backplane supports hot swapping, see your system documentation.

Hot-swapping is the manual replacement of a disk while the PERC S150 is online and performing its normal functions. The following requirements must be met before hot-swapping a physical disk:

- The system backplane or enclosure must support hot swapping for the PERC S150.
- The replacement disk must be of the same protocol and disk technology. For example, only a SATA hard drive can replace a SATA hard drive and only a SATA SSD can replace a SATA SSD.

**NOTE:** Disk hot-swapping is not supported in UEFI HII; it is supported only in OS mode.

**NOTE:** When hot-swapping a physical disk, ensure that the new disk is of equal or greater capacity to the physical disk that is being replaced.

### Physical disk power management

Power management is a power-saving feature of the PERC S150. This feature supports power management of SATA hard drives (HDD) by using Extended Power Conditions (EPC). The EPC feature set provides the host with additional methods to control the power condition of a device.

### Physical disk failure detection

Physical disk failure is detected and the controller automatically rebuilds a new physical disk assigned as a hot spare.

**NOTE:** Refer to drive mixing restrictions for rebuilding.

## Mirror rebuilding

A RAID mirror configuration can be rebuilt after a new physical disk is inserted and the physical disk is designated as a hot spare.

**NOTE:** The system does not have to be rebooted.

## Fault tolerance

The following fault tolerance features are available with the PERC S150:

- Physical disk failure detection (automatic).
- Virtual disk rebuild using hot spares (automatic, if the hot spare is configured for this feature).
- Parity generation and checking (RAID 5 only).
- Hot-swap manual replacement of a physical disk without rebooting the system (only for systems with a backplane that allows hot-swapping).

If one side of a RAID 1 (mirror) fails, data can be rebuilt by using the physical disk on the other side of the mirror.

If a physical disk in RAID 5 fails, parity data exists on the remaining physical disks, which can be used to restore the data to a new replacement physical disk configured as a hot spare.

If a physical disk fails in RAID 10, the virtual disk remains functional and data is read from the surviving mirrored physical disk(s). A single disk failure in each mirrored set can be sustained, depending on how the mirrored set fails.

## Self-monitoring and reporting technology

The self-monitoring and reporting technology (SMART) feature monitors certain physical aspects of all motors, heads, and physical disk electronics to help detect predictable physical disk failures. Data on SMART compliant physical disks can be monitored to identify changes in values and determine whether the values are within the threshold limits. Many mechanical and electrical failures display some degradation in performance before failures.

A SMART failure is also referred to as a predicted failure. There are numerous factors that are predicted as physical disk failures, such as a bearing failure, a broken read/write head, and changes in spin-up rate. In addition, there are factors related to read/write surface failures, such as seek error rate and excessive bad sectors.

**NOTE:** For detailed information on SCSI interface specifications, see [t10.org](http://t10.org), and for detailed information on SATA interface specifications, see [t13.org](http://t13.org).

## Native Command Queuing

Native Command Queuing (NCQ) is a command protocol used by SATA physical disks supported on the S150 controller. NCQ allows the host to provide multiple input/output requests to a disk simultaneously. The disk decides the order to process the commands to achieve maximum performance.

## NVMe PCIe SSD support

S150 supports the NVMe PCIe SSD-including the NVMe PCIe SSD 2.5-inch Small Form Factor (SFF), NVMe PCIe SSD Adapter, and E.3 form factor drives.

The S150 supports the NVMe PCIe SSD 2.5-inch SFF and the NVMe PCIe SSD Adapter in a RAID configuration. The NVMe PCIe SSD supports volume, non-RAID, RAID 0, RAID 1, RAID 5, and RAID 10. The S150 also supports the Prepare to remove feature to remove the non-RAID NVMe drive from a Dell OpenManage console.

In UEFI HII mode, you can use the NVMe PCIe SSD option on the device settings page to view NVMe physical disk properties and perform blink or unblink operations.

**Table 6. OS and UEFI drivers supported by PERC S150**

Drives	S150 operating system driver	S150 UEFI driver
Samsung PM1733/PM1735	6.7.0.0003	6.7.0.0003

**Table 6. OS and UEFI drivers supported by PERC S150 (continued)**

Drives	S150 operating system driver	S150 UEFI driver
Intel P5500/P5600	6.7.0.0003	6.7.0.0003
Kioxia CM6/CD6	6.7.0.0003	6.7.0.0003
Intel P5800x	6.7.0.0003	6.7.0.0003
Hynix PE8010	6.7.0.0003	6.7.0.0003
SAMSUNG PM9A3	6.7.0.0003	6.7.0.0003
Samsung PM 1733a/ PM1735a	6.7.0.0003	6.7.0.0003
Intel 5520/5620	6.7.0.0003	6.7.0.0003
Kioxia CD7	6.7.0.0003	6.7.0.0003
Samsung PM1743/45	6.7.0.0003	6.7.0.0003
Micron 7450	6.7.0.0003	6.7.0.0003
Micron 7500	6.7.0.0003	6.7.0.0003
KIOXIA CM7 and KIOXIA CD8	6.7.0.0003	6.7.0.0003
Toshiba CD5 and Toshiba CM5	6.7.0.0003	6.7.0.0003
Intel P4800 or P4800X	6.7.0.0003	6.7.0.0003
Intel P4500, Intel P4510, Intel P4600, or Intel P4610	6.7.0.0003	6.7.0.0003
Samsung 1725, Samsung 1725a	6.7.0.0003	6.7.0.0003

- NOTE:** Hot removal or hot insertion of the NVMe PCIe SSDs in UEFI or pre-boot mode is not supported. In the operating system environment, hot-swapping two or more NVMe PCIe SSDs simultaneously is not supported.
- NOTE:** Mixing of SATA drives and NVMe PCIe SSDs in a virtual disk is not supported.
- NOTE:** Ensure that you use only the S150 UEFI configuration utility to configure the NVMe PCIe SSDs during preboot.
- NOTE:** RAID configuration and boot from NVMe virtual disk is supported only in UEFI boot mode.
- NOTE:** RAID configuration using Option ROM (OPROM) is not supported on systems with the NVMe PCIe SSD.
- NOTE:** Software RAID limits the number of NVMe drives supported to 30 with a maximum of three (3) NVMe backplanes in a system. Therefore, in any system that supports more than three Software RAID supported backplanes, the Prepare to Remove operation is not supported by OMSA.
- NOTE:** When there are more NVMe drives (say, greater than 20) configured under software RAID, if the initialization of few NVMe drives gets delayed from operating system, then there is a remote possibility of the corresponding VDs getting marked as degraded or failed. A change in the VD status shall be indicated on the HII when the system is restarted the next time. To avoid VD degradation, global hot spare is recommended for such large NVMe configurations.

## Physical disk write cache policy for SATA drives

The physical disk write cache policy feature enables the disk to cache the data first, and then the cached data is written to the storage device in the background. For more information about managing the physical disk write cache policy, see [Managing the physical disk write cache policy for SATA drives](#).

- NOTE:** You can use UEFI or Option ROM (OPROM) to configure the physical disk write cache policy.
- NOTE:** You cannot configure a physical disk write cache policy on a non-RAID disk.

 **NOTE:** Linux RAID does not support configuring physical disk write cache policy, or virtual disk write cache policy.

## Linux RAID

Linux operating systems supported:

- Red Hat Enterprise Linux 8.0 and above
- SUSE Linux Enterprise Server version 15 SP1 and above

The Linux RAID feature is supported on all Sirius PowerEdge systems. You can use Linux RAID to protect data across multiple devices. The S150 configuration utility supports configuring RAID 1 virtual disk in UEFI mode. The Linux operating system can be installed on that virtual disk, and once the system boots to the Linux environment, the Linux native RAID driver manages the virtual disk. For information about configuring Linux RAID, see [Configuring Linux RAID](#).

 **NOTE:** Ensure that your system has the latest BIOS firmware. You can download the latest BIOS firmware from [Dell Support Site](#).

 **NOTE:** Ensure that you use only the S150 UEFI configuration utility to configure Linux RAID feature during pre-boot.

 **NOTE:** Ensure that the boot virtual disks are configured in RAID 1, using two physical disks of identical drive type (HDD or SSD) and sector size. However, you can also configure nonboot virtual disks in any of the supported RAID levels in the Linux operating system.

 **NOTE:** NOTE: Before installing RHEL 8.8 on PERC S140, PERC S150, or PERC S150, ensure that the Intel Rapid Storage Technology (AHCI) driver is installed. Intel Rapid Storage Technology driver also supports Firmware based RAID. See [RHEA-2023:5916 - Product Enhancement Advisory - Red Hat Customer Portal](#).

# Virtual Disks

A logical grouping of physical disks attached to a PERC S150 allows you to create multiple virtual disks of the same RAID levels, without exceeding a maximum of 30 virtual disks.

The PERC S150 controller allows:

- Creating virtual disks of different RAID levels on a S150 controller.

**i** **NOTE:** Ensure that you do not mix RAID levels on the same physical disks.

- Building different virtual disks with different characteristics for different applications.
- Creating virtual disks from a mix of NVMe PCIe SSD 2.5-inch SFFs and NVMe PCIe SSD adapters.

The PERC S150 controller does not allow:

- Creating a virtual disk from a mix of different types of physical disks. For example, a RAID 10 virtual disk cannot be created from two SATA HDD physical disks and a SATA SSD physical disk. All the physical disks must be of the same drive type (HDD/SSD/NVMe PCIe SSDs).
- Selecting a physical disk as a dedicated hot spare if the physical disk is a different type from the physical disk of the virtual disks.

A virtual disk refers to data storage which a controller creates using one or more physical disks.

**i** **NOTE:** A virtual disk can be created from several physical disks; the operating system considers it a single disk.

The capacity of a virtual disk can be expanded online for any RAID level without rebooting the operating system.

**i** **NOTE:** If the boot VD is spanned across different SATA controllers, then Windows Hardware Quality Labs testing (WHQL), DF - Reinstall with I/O Before and After (Reliability) fails in a server having two SATA controllers.

## Topics:

- [Virtual disk features](#)
- [Disk initialization](#)
- [Background Array Scan](#)
- [Checkpointing](#)
- [Virtual disk cache policies](#)
- [Virtual disk migration](#)
- [Expanding virtual disk capacity](#)

## Virtual disk features

### TRIM for SATA SSDs

The TRIM command allows an operating system to delete a block of data that is no longer considered in use from the SATA SSDs. TRIM resolves the Write Amplification issue for supported operating systems. When an operating system deletes a file, the file is marked for deletion in the file system, but the contents on the disk are not actually erased. As a result, the SSDs do not know that the Logical Block Addressing (LBA) file previously occupied can be erased. With the introduction of TRIM, when a file is deleted, the operating system sends a TRIM command along with the LBAs that do not contain valid data.

**i** **NOTE:** The TRIM feature is supported only on pass-through SSDs.

**i** **NOTE:** The TRIM feature is not supported on NVMe PCIe SSDs.

## To perform TRIM on the pass-through SSDs

1. Create a volume on a pass-through SSD drive.
2. In the Windows operating system, navigate to the **Defragmentation and Optimize Drive** tool.
3. Select the volume created on the pass-through SSD and click **Optimize**.  
TRIM is applied.

## Disk initialization

For physical disks, initialization writes metadata to the physical disk so that the controller can use the physical disk.

## Background Array Scan

Verifies and rectifies correctable media errors on mirror, volume, or parity data for virtual disks. Background Array Scan (BAS) starts automatically after a virtual disk is created while in the Windows operating system.

 **NOTE:** When the PERC S150 drivers are installed on a server that is running the Windows operating system, the hard drive LED blinks continuously if the BAS feature is enabled.

## Checkpointing

Allows different types of checkpointing to resume at the last point following a restart. After the system restarts, background checkpointing resumes at its most recent checkpoint.

Three types of checkpointing are available:

- Consistency Check (CC)
- Background Initialization (BGI)
- Rebuild

## Consistency check

Consistency check (CC) is a background operation that verifies and corrects the mirror or parity data for fault-tolerant physical disks. It is recommended that you periodically run a consistency check on the physical disks.

By default, CC corrects mirror or parity inconsistencies. After the data is corrected, the data on the primary physical disk in a mirror set is assumed to be the correct data and is written to the secondary physical disk mirror set.

The CC operation reports data inconsistencies through an event notification. A CC cannot be user-initiated in the BIOS configuration utility, accessed using Ctrl + R. However, CC can be initiated using OpenManage Server Administrator Storage Management. For more information, see the OMSA user's guide at [OpenManage Documentation](#).

## Background initialization

Background initialization (BGI) of a redundant virtual disk creates the parity data that allows the virtual disk to maintain its redundant data and survive a physical disk failure. Similar to CC, BGI helps the controller to identify and correct problems that might occur with the redundant data at a later time.

 **CAUTION:** Data is lost if a physical disk fails before the completion of a BGI operation.

BGI allows a redundant virtual disk to be used immediately.

 **NOTE:** Although a BGI is software-initiated from within the **BIOS Configuration Utility** (accessible through Ctrl + R), the PERC S150 drivers must be loaded before the BGI runs.



## Automatic virtual disk rebuild

Rebuilds a redundant virtual disk automatically when a failure is detected if a hot spare is assigned for this capability.

## Virtual disk cache policies

**NOTE:** Configuring virtual disk cache policies on NVMe PCIe SSD is not supported.

The PERC S150 uses part of system memory for cache. It supports the following cache options:

- Read Ahead/Write Back
- No Read Ahead/Write Back
- Read Ahead/Write Through
- No Read Ahead/Write Through

**Table 7. Read, Write, and Cache Policy for the PERC S150**

Category	Supported by S150 controller
Cache settings	Yes
Read Ahead/Write Back	Yes
No Read Ahead/Write Back	Yes
Read Ahead/Write Through	Yes
No Read Ahead/Write Through	Yes

**NOTE:** The current default for Write-Cache mode enablement is **No Read Ahead, Write Through (NRA, WT)**. To enable **Write Back (WB)**, a UPS is recommended.

**NOTE:** For more information about the physical disk write cache policy behavior, see [Troubleshooting your system](#).

## Virtual disk migration

The PERC S150 supports automatic virtual disk migration from one PERC S150 to another.

**CAUTION:** The virtual disk is lost if you perform a virtual disk migration during an Online Capacity Expansion (OCE)/Reconfigure.

**NOTE:** Back up the virtual disk data before migrating virtual disks.

**NOTE:** Ensure that all physical disks that are part of the virtual disk are migrated. Virtual disks in optimal and degraded states are automatically migrated. A virtual disk in an offline state should not be migrated.

**NOTE:** A bootable virtual disk cannot be migrated between dissimilar system models.

**NOTE:** When you migrate virtual disks, ensure that you verify that the number of virtual disks does not exceed 10.

## Migrating a virtual disk

1. Turn off the system that contains the source controller.
2. Turn off the target system if the system does not support hot swap of physical disks.
3. Move the appropriate physical disks from the source controller to the target controller in the target system. Physical disks do not have to be inserted into the same slots in the target system.
4. If the target system was turned off, turn on the system.

 **CAUTION:** The BIOS Configuration Utility pauses, and prompts for action, for the degraded virtual disk(s), if the "pause if degraded" option is enabled in the BIOS Configuration Utility.

 **CAUTION:** After the migration occurs, ensure that all of the physical disks have been migrated and are present in the appropriate virtual disks.

## Expanding virtual disk capacity

The capacity of a virtual disk can be expanded online by using the Online Capacity Expansion/Reconfigure (OCE/Reconfigure). OCE/Reconfigure is a process that allows you to add storage capacity to an existing virtual disk. In most cases additional storage capacity can be added without taking the system offline.

OCE/Reconfigure enables you to increase the total storage capacity of a virtual disk by integrating unused storage with the virtual disk.

Data can be accessed while the physical disks are added (if a system has hot-swap capability) and while data on the virtual disk is being redistributed.

 **NOTE:** If an additional physical disk is required and the system does not support hot-swapping, the system must be turned off.

For volume, RAID 1, and RAID 10, OCE/Reconfigure expands the virtual disk by using the available space of the physical disks, which have been members of the virtual disk. For RAID 0 and RAID 5, additional capacity can be attained by adding physical disks to the virtual disk.

 **NOTE:** There will be performance degradation until the capacity expansion is completed.

 **NOTE:** While the process of expanding the capacity of a virtual disk is in progress, removing and reinserting a drive that is part of this virtual disk is not supported. Users can reinsert the drive after the capacity expansion process is completed.

# Cabling the drives for the S150

**CAUTION:** Many repairs may only be done by a certified service technician. You should only perform troubleshooting and simple repairs as authorized in your product documentation, or as directed by the online or telephone service and support team. Damage due to servicing that is not authorized by Dell is not covered by your warranty. Read and follow the safety instructions that are shipped with your product.

**NOTE:** For information on removing and reinstalling system parts, see the PowerEdge systems owner's manuals at [dell.com/poweredgemanuals](http://dell.com/poweredgemanuals).

This section provides details about cabling for the integrated PERC S150 controller.

**NOTE:** For information about cabling SATA and NVMe PCIe SSDs for S150, see your system owner's manual at [dell.com/poweredgemanuals](http://dell.com/poweredgemanuals).

1. Turn off the system, including any attached peripherals, and disconnect the system from the electrical outlet and peripherals.

**NOTE:** It is recommended that you always use a static mat and static strap while working on components in the interior of the system.

2. Remove the system cover.
3. Locate the connectors SATA\_A and SATA \_B on the system board.
4. Connect the SATA\_A and SATA \_B connectors on the AHCI devices to the corresponding cable connectors on the backplane using the SATA cables.

**NOTE:** The first AHCI device provides connectivity to the drives available on port 0–7 and the second AHCI device provides connectivity to the drives available on port 8. For information about disk connectivity for AHCI devices, see [Disk connectivity for AHCI devices](#)

5. Install the system cover.
6. Turn on the system.

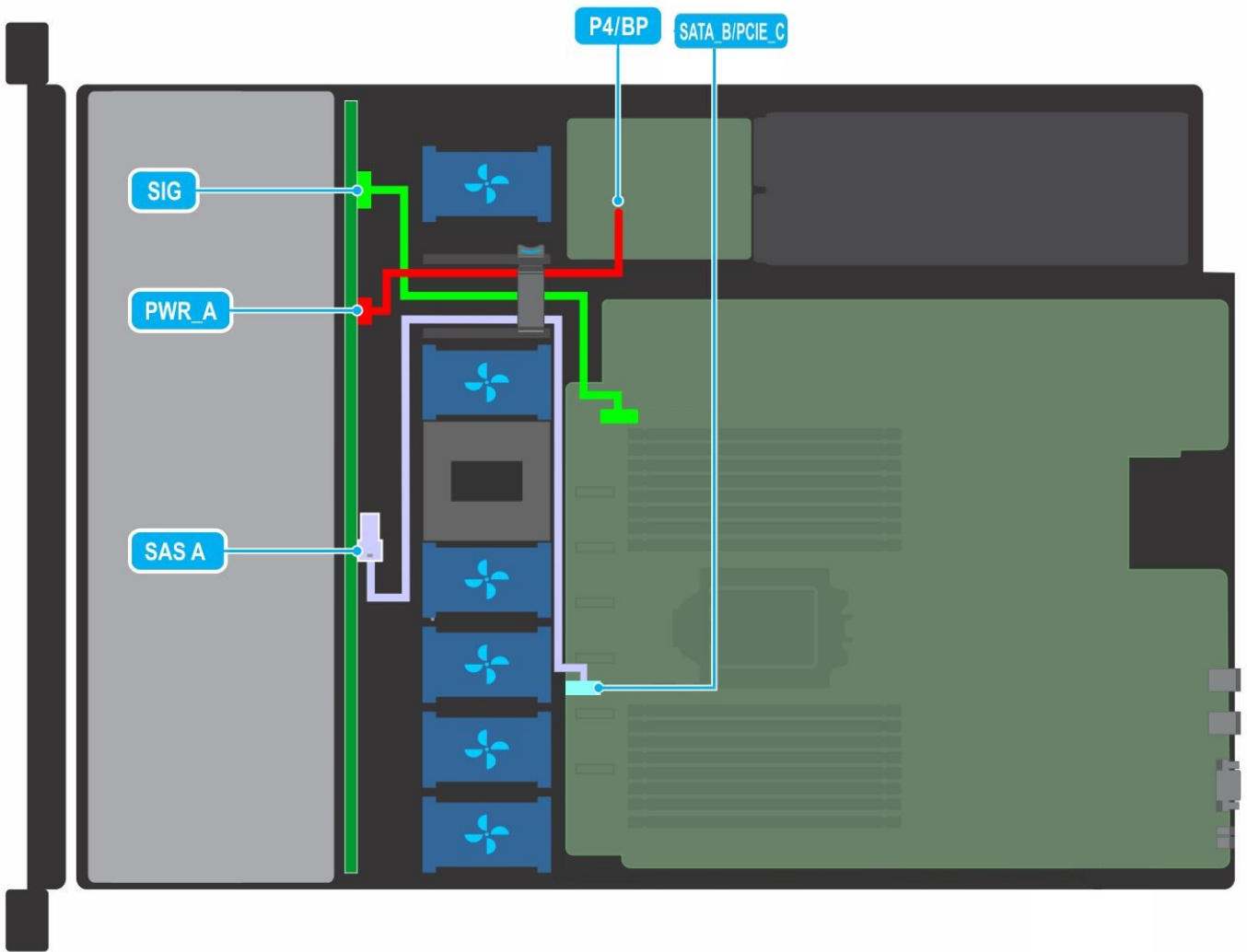

Figure 1. Cable routing - 4 x 3.5 inch SATA drive backplane

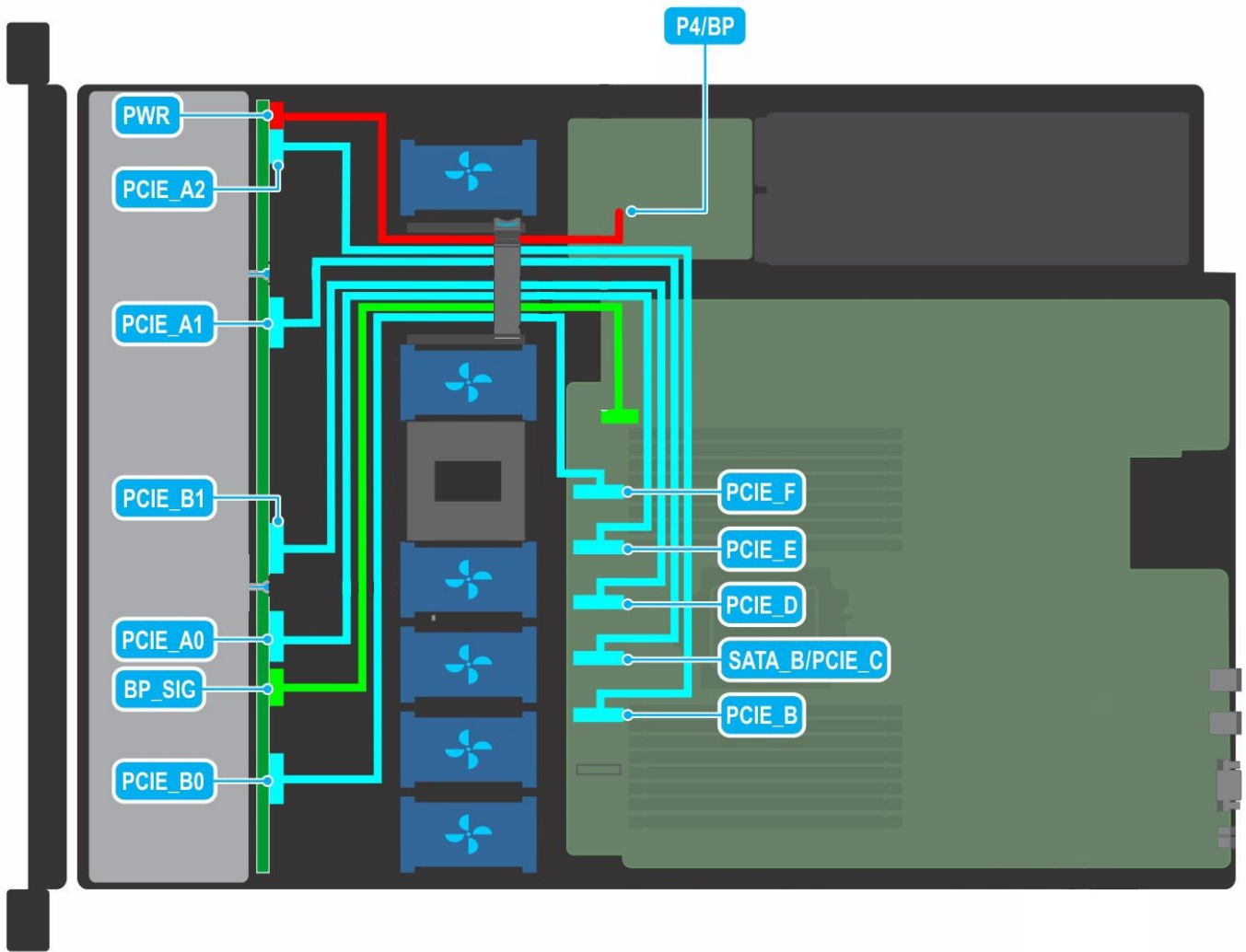

Figure 2. Cable routing - 10 x 2.5 inch NVMe drive backplane

**Topics:**

- Disk connectivity for AHCI devices

## Disk connectivity for AHCI devices

The S150 controller supports systems with up to two AHCI devices. For systems with two AHCI devices, the first AHCI device connects the drives from ports 0–7 and the second AHCI device connects the drives from port 8.

The following table provides information about the disks connectivity to the AHCI devices supported on the 15G PowerEdge systems.

**Table 8. Disk connectivity for AHCI devices**

Chipset	Platform	AHCI device 1	AHCI device 2
AMD EPYC 7002 series processor	PowerEdge R6515, R7515, R7525, R6525, and C6525	0-7	8

**Table 8. Disk connectivity for AHCI devices (continued)**

<b>Chipset</b>	<b>Platform</b>	<b>AHCI device 1</b>	<b>AHCI device 2</b>
Intel C621A	PowerEdge R650, R750, R750 XA, C6520, Mx750c, R550, R450, R650XS, R750 XS, T550, XR11, XR12, T150, T350, R250, R350, and XE8545.	0-5	6-13

# BIOS Configuration Utility

The BIOS Configuration Utility, also known as Ctrl+R or Option ROM (OPROM), is a storage management application integrated into the System BIOS accessible using F2 during system boot, which configures and maintains RAID disk groups and virtual disks on SATA drives. The **BIOS Configuration Utility (Ctrl+R)** is independent of the operating system.

**NOTE:** Use the **Ctrl+R** for initial setup and disaster recovery. You can use advanced features through OpenManage storage management applications.

**NOTE:** Configuring NVMe PCIe SSDs is not supported using the BIOS configuration utility.

**NOTE:** Ensure that you use only the S150 UEFI configuration utility to configure the NVMe PCIe SSDs during preboot. To enable RAID mode for NVMe PCIe SSDs, see [Setting the NVMe PCIe SSDs to RAID mode](#).

**NOTE:** RAID configuration using OPROM is not supported on systems with the NVMe PCIe SSD.

The following sections provide information about using the **Ctrl+R**. For more information, see the online help option by pressing F1 in the **Ctrl+R**.

The table below indicates the tasks that are supported or not supported by the PERC S150 at the **Ctrl+R**.

**Table 9. BIOS Configuration Utility (Ctrl+R) Tasks**

PERC S150 tasks	Supported by S150
Enable alarm	No
Disable alarm	No
Quiet alarm	No
Test alarm	No
Set check consistency rate	No
Rescan controller	Yes
Create virtual disk	Yes

## Topics:

- [Entering the BIOS configuration utility](#)
- [Exiting the BIOS Configuration Utility](#)
- [Initializing the physical disks](#)
- [Creating the virtual disks](#)
- [Deleting the virtual disks](#)
- [Swapping two virtual disks](#)
- [Managing the hot spare disks](#)
- [Viewing the physical disks details](#)
- [Viewing the virtual disks details](#)
- [Rescan disks](#)
- [Controller Options](#)
- [Continue to boot](#)

## Entering the BIOS configuration utility

1. Turn on the system.
2. While the system starts up, press Ctrl+R to boot to the BIOS configuration utility.

 **CAUTION:** If the SATA controller is not set to RAID Mode, data might be destroyed. Ensure that you backup all data before changing modes.

 **NOTE:** If the BIOS Configuration Utility <Ctrl><R> does not appear and your system uses a PERC S160 or PERC S150, press F2 to access the system BIOS. In the **SATA Settings** field, ensure that SATA controller is set to RAID Mode. If the settings are correct and the BIOS Configuration Utility <Ctrl><R> does not appear, contact Dell support at [Dell Support Site](#).

## Exiting the BIOS Configuration Utility

1. Press Esc in any menu screen.  
A dialog box is displayed to confirm your choice.
2. Select C to exit or press Esc to cancel.

## Initializing the physical disks

New physical disks must be converted to RAID capable disks before they can be used. When you convert a disk to a RAID capable disk, the controller configuration information is written to the physical disk.

Physical disks with the following status can be initialized:

- |                 |  |
|-----------------|--|
| <b>Non-RAID</b> | A physical disk that was configured by a non-PERC S150.              |
| <b>Ready</b>    | Contains no stored data but has PERC S150 configuration information. |

 **NOTE:** Physical disks that are online cannot be converted to Non-RAID or RAID capable disks.

1. Enter the BIOS configuration utility. See [Entering the BIOS configuration utility](#).
2. In the **Main Menu** field use the arrow keys to select the **Initialize Physical Disks** option.
3. Press Enter.  
The **Initializing the physical disks** screen is displayed.

## Converting to RAID disks

 **WARNING:** You may lose data while converting a disk to a RAID disk.

1. Enter the BIOS configuration utility. See [Entering the BIOS configuration utility](#).
2. Use the arrow keys to select **Initializing the physical disks** menu and press Enter.
3. Select **Convert to RAID disk** and press Enter.
4. Press C to continue.
5. In the **Physical Disks** menu, use the arrow keys to move between the physical disks and press Insert to select the desired physical disk.
6. Press Enter.  
The selected physical disk is converted to a RAID capable disk.

 **NOTE:** In Convert to RAID mode, initialized RAID disks can be initialized again.

## Converting to Non-RAID disks

 **WARNING:** You may lose data while converting a disk to a Non-RAID disk.

1. Enter the BIOS configuration utility. See [Entering the BIOS configuration utility](#).
2. Use the arrow keys to select **Initializing the physical disks** menu and press Enter.
3. Select **Convert to Non-RAID disk** and press Enter.
4. Press C to continue.



5. In the **Physical Disks** menu, use the arrow keys to move between the physical disks and press Insert to select the desired physical disk.
6. Press Enter.  
The selected physical disk is converted to Non-RAID disks.

## Creating the virtual disks

1. Enter the **BIOS Configuration Utility**. See [Entering the BIOS configuration utility](#).
2. Select **Create Virtual Disks** from the **Main Menu** screen and press <Enter>.
  -  **NOTE:** The S150 controller supports a maximum of 30 virtual disks. You cannot modify any feature settings in UEFI or OPROM if the number of virtual disks exceeds the maximum limit of 30. For more information about troubleshooting this issue, see [Unable to modify any feature settings in UEFI or OPROM](#).
3. In the **Physical Disks** field, select the physical disk on which you want to create a virtual disk:
  - a. To select a physical disk, press Insert.
  - b. After selecting the physical disk to be included in the virtual disk, press Enter.
4. In the **User Input** field, use the arrow keys to select a virtual disk type (RAID level) and press Enter.
5. Select a size for the virtual disk, depending on the available free space of the physical disks and press Enter.
6. In the **User Input** field, select a **Caching Mode**. Press Enter.
7. Press C to confirm that you want to create the virtual disk.

## Selecting virtual disk sizes while creating a virtual disk



To create a virtual disk size of < 2.199 TB:

1. Use the up arrow or page up keys to select a size displayed incrementally, or use the down arrow or page down keys to select a size displayed decrementally.
  -  **NOTE:** To increase the size by 10 units use the page up key and to increase the size by one unit use the up arrow key and conversely.
2. Continue with [Creating the virtual disks](#).

To create a virtual disk size of > 2.199 TB:

1. Press the Page Up or the up arrow key to increase the virtual disk size. At the maximum size, a dialog box is displayed in the **User Input** field. It inquires if you want to limit the size of the virtual disk or exceed the normal maximum size.
2. Press Esc to create a larger virtual disk.
3. Press the Page Up or the up arrow key until the desired or maximum available size has been attained.
4. Continue with [Creating the virtual disks](#).

## Deleting the virtual disks

1. Enter the **BIOS Configuration Utility**. See [Entering the BIOS configuration utility](#).
2. In the **Main Menu** screen, select **Deleting Virtual Disk** using the arrow keys and press Enter.
3. Select each virtual disk in the **Virtual Disks** field that you want to delete. Press Insert to confirm each selection.
4. Press Enter.
  -  **CAUTION: Deleting a virtual disk permanently destroys all data that is on the virtual disk, as well as the virtual disk itself. This action cannot be undone.**
5. Press C to confirm the deletion.
  -  **NOTE:** When a degraded or a failed virtual disk from one system is added to another system, and if the number of virtual disks exceeds the maximum limit of 30, you cannot delete the virtual disks that are in the **Normal** or **Ready** states.

# Swapping two virtual disks

1. Enter the **BIOS Configuration Utility**. See [Entering the BIOS configuration utility](#).
2. In the **Main Menu** screen, select the **Swapping Two Virtual Disks** and press Enter.
3. Use the arrow keys to highlight a virtual disk at the **Virtual Disk** field. Press Insert.
4. Use the arrow keys to highlight another virtual disk. Press Insert.
5. Press Enter to swap the virtual disks.

**NOTE:** Only two virtual disks can be swapped at a time.

**NOTE:** When you create up to 30 virtual disks and swap the virtual disks using the **BIOS Configuration Utility**, the order of the virtual disk in option ROM (OPROM) appears different from the order of the virtual disk in operating system.

# Managing the hot spare disks

**Manage Hot Spare(s)** screen enables you to assign or unassign a global or dedicated hot spare(s).

1. Enter the BIOS Configuration Utility. See [Entering the BIOS configuration utility](#).
2. In the **Main Menu** screen, use the arrow keys to select **Manage Hot Spare(s)** and press <Enter>. The **Manage Hot Spare(s)** screen display:
  - global hot spare disks
  - dedicated hot spare disks

# Assigning the global hot spare disks

A global hot spare disk is a backup physical disk that can be used by any redundant virtual disk. It is not assigned (dedicated) to any specific virtual disk. Virtual disks can typically be rebuilt by using a global spare disk, as long as the global hot spare is not already part of the virtual disk and has enough available capacity. Unlike a dedicated hot spare, a global hot spare can be assigned at anytime, even while tasks are running on virtual disks.

**NOTE:** A hot spare can be created only if a physical disk is in the **Ready** or **Normal** state in the **Physical Disks** field. If the physical disk is in the **Online** state, the disk is being used by a virtual disk and cannot be selected as a hot spare.

**NOTE:** If disk space is available in the global hot spare drive then a single global hot spare can be assigned as a hot spare to multiple degraded virtual drives. Therefore, it is possible for the same global hot spare to become part of different degraded virtual drives that have different RAID levels.

Perform the following procedure to assign a global hot spare disk:

1. Enter the **BIOS Configuration utility**. See [Entering the BIOS configuration utility](#).
2. In the **Main Menu** screen, select the **Manage Hot Spare** and press <Enter>.
3. Select **Assign Global Hot Spare(s)**. Press <Enter>.
4. Use the up or down arrow key to select a physical disk(s) to be used as a global hot spare(s). Press <Insert>.
5. Press <Enter> to add the global hot spare.
6. Press the <C> key to confirm the action.

# Unassign hot spare disks

1. Enter the **BIOS Configuration utility**. See [Entering the BIOS configuration utility](#).
2. In the **Main Menu** screen, select the **Manage Hot Spare** and press Enter.
3. Select **Unassign Hot Spare**. Press Enter.
4. Use the up or down arrow key to select the physical disk to delete as a hot spare.
5. Press Insert. To delete the hot spare, press Enter
6. Press the C key to confirm the action.

## Viewing the physical disks details

1. Enter the **BIOS Configuration Utility**. See [Entering the BIOS configuration utility](#).
2. In the **Main Menu** screen, select **View Physical Disk Details** and press <Enter>.
3. Use the arrow keys to choose a physical disk.
4. The following details of the physical disks are displayed:
  - a. Physical disk number
  - b. Channel number
  - c. Physical disk size
  - d. Physical disk status: **Non-RAID/Ready/Online**
  - e. Amount of free space
  - f. Manufacturer and model number
  - g. World Wide Address
  - h. SATA Cache Policy (Enabled or Disabled)
  - i. S.M.A.R.T. State: Error (if a disk with a S.M.A.R.T. error is discovered)
5. Press <Esc> to return to the main window.

## Viewing the virtual disks details

1. Enter the **BIOS Configuration Utility**. See [Entering the BIOS configuration utility](#).
2. In the **Main Menu** screen, select **View Virtual Disk Details** and press <Enter>.
3. Use the arrow keys to choose a virtual disk.
4. The following details of the virtual disks are displayed:
  - a. Virtual disk number
  - b. RAID Level
  - c. Size
  - d. Status (**Read Ahead/Write Back, No Read Ahead/Write Back, Read Ahead/Write Through, No Read Ahead/Write Through**)

 **NOTE:** A maximum of only 10 VD's can be displayed in the OPROM user interface.

5. Press <Esc> to return to the main window.

 **NOTE:** The **Physical Disks** field indicates the physical disks that are in the virtual disk, highlighted by green text.

## Rescan disks

This option allows you to view the list of existing Physical and Virtual disks.

 **NOTE:** The Rescan disks option may take from 10 to 20 seconds to display the list of disks, depending on the number of disks available in the system.

1. Enter the **Dell PERC S150 Configuration Utility**. See [Entering the DELL PERC S150 Configuration Utility](#).
2. Click **Controller Management > Rescan Disks**.  
The **Rescan Disks** screen is displayed. It provides information about the latest physical disk and virtual disk configurations.

## Controller Options

The **Controller Options** feature helps you to enable the **BIOS Stop on Error** option. The boot process pauses when **Pause if...** is enabled and a virtual disk becomes **Degraded** or has **Failed**. Press <Enter> to continue booting.

View the error message on the window. If **Pause...** is **OFF**, the error message is displayed briefly, but the system continues to boot.

1. Enter the **BIOS Configuration Utility**. See [Entering the BIOS Configuration Utility](#).

2. In the **Main Menu** screen, use the arrows to select the **Controller Options**.
3. In the **Controller Options** field, use the up or down arrow keys to scroll to the desired controller option.
  - a. **Pause if Degraded**

When **ON**, the BIOS stops booting when a degraded virtual disk is found.  
Press <Enter> to toggle between **ON** and **OFF**.
  - b. **Pause if Failed**



When **ON**, the BIOS stops booting when a failed virtual disk is found.  
Press <Enter> to toggle between **ON** and **OFF**.
  - c. **Manage Physical Disk Write Cache**
    - If the option is set to **Default**:
      - The physical disk write cache policy is enabled for SSDs and HDDs of bandwidth 3 Gbps.
      - The physical disk write cache feature is disabled for HDDs of bandwidth 6 Gbps.
    - If the option is set to **Enable**, the feature is enabled on the disk selected.
    - If the option is set to **Disable**, The feature is disabled on the disk selected.
4. Press Esc to return to the main window.

## Continue to boot

1. Enter the **BIOS Configuration Utility**. See [Entering the BIOS configuration utility](#).
2. In the **Main Menu** screen, use the arrows to select the **Continue to Boot**.  
The system restarts normally.

# UEFI RAID configuration utility

The Unified Extensible Firmware Interface (UEFI) RAID configuration utility is a storage management application integrated into the System BIOS F2. It is used to configure and manage RAID, virtual disks, and physical disks. This utility is independent of the operating system.

-  **NOTE:** The following sections provide information about using the UEFI RAID configuration utility. For more information, see the online help option in the UEFI RAID configuration utility.
-  **NOTE:** Ensure that you use only the S150 UEFI configuration utility to configure the NVMe PCIe SSDs during preboot. To enable RAID mode for NVMe PCIe SSDs, see [Setting the NVMe PCIe SSDs to RAID mode](#)
-  **NOTE:** Use the UEFI RAID configuration utility for initial setup.



## Topics:

- [Entering the DELL PERC S150 Configuration Utility](#)
- [Exiting the DELL PERC S150 Configuration Utility](#)

## Entering the DELL PERC S150 Configuration Utility

1. Turn on the system.
2. While the system starts up, press <F2> to enter **System Setup**.  
The list of menu items in the **System Setup Main Menu** screen is displayed.
3. Click **Device Settings**.  
**Device Settings** lists the NIC ports and all the options of the S150 configuration utility.

To access the management menu for the controller, use the arrow keys or the mouse.

-  **NOTE:** For more information on all the options, click **Help** in the top right-hand corner of the browser screen. Help information for individual option menus can also be viewed by scrolling down on each option.
  -  **NOTE:** Some of the options within the UEFI RAID configuration utility are not present if the controller does not support the corresponding feature. Options may also be grayed out if the feature is not supported in existing configuration.
4. Click **Dell PERC S150 Configuration Utility**.  
Displays the list of **Configuration Options**:

**Table 10. Configuration Options**

Configuration Options	Description
<b>Controller Management</b>	allows you to configure, manage, and view the controller properties.
<b>Virtual Disk Management</b>	allows you to configure, manage, and view the virtual disk properties.
<b>Physical Disk Management</b>	allows you to configure, manage, view and perform varied operations on the physical disk properties.

-  **NOTE:** Loading default settings in this page by clicking on **Default** button will not cause any changes in the controller settings.

## Exiting the DELL PERC S150 Configuration Utility

To exit the utility and return to the System Setup screen, click **Finish** in the bottom-right corner on the screen.

# Controller management

## Viewing the controller properties

The **View Controller Information** screen allows you to view your controller and firmware properties.

In the **System Setup Main Menu**, click **Device Settings > Dell PERC S150 Configuration Utility > Controller Management > View Controller Information**

The table explains the **View Controller Information** screen details:

**Table 11. View Controller Information**

Menu Item	Description
PCI ID	Displays the PCI ID
Physical disk Count	Displays the total number of physical disks available on the system
Virtual Disk Count	Displays the total number of virtual disks available
UEFI Driver Version	Displays the UEFI driver version installed on the system
Firmware Build Time	Displays the time and date the firmware was last updated.

## Changing the boot order of the virtual disks

**Set Bootable Device** allows you to change the boot order of the virtual disks.

1. Enter the **Dell PERC S150 Configuration Utility**. See [Entering the DELL PERC S150 Configuration Utility](#).
2. Click **Controller Management > Change Controller Properties**.
3. Click **Set Bootable Device**.  
A **Change Order** dialog box displays the list of virtual disks available.
4. Use the arrow keys to set a virtual disk and **+** or **-** to change the order of the virtual disks that need to be booted first.
5. Click **Ok**.  
The changes to the boot order of the virtual disks are displayed.

## Stopping the system from booting if there is a critical BIOS error

The **Change Controller Properties** screen allows you to either enable or disable the option to stop the system from booting if there is any critical BIOS error requiring manual intervention.

1. Enter the **Dell PERC S150 Configuration Utility**. See [Entering the DELL PERC S150 configuration utility](#).
2. Click **Controller Management > Change Controller Properties**.
3. You can either enable or disable the **Enable BIOS Stop On Error**.

## Converting a physical disk to a Non-RAID disk

1. Enter the **Dell PERC S150 Configuration Utility**. See [Entering the DELL PERC S150 Configuration Utility](#)
2. Click **Controller Management > Convert to Non-RAID Disk**.
3. Select the interface type.
4. Select the **physical disks**. Click **Check All** to select all the disks available.
5. Click **Apply Changes**.

## Converting physical disk to RAID capable disk

 **CAUTION:** Any data already existing on the disk will be lost during this operation. Ensure that you have backed up critical data before converting the physical disk to a RAID capable disk.

1. Enter the **Dell PERC S150 Configuration Utility**. See [Entering the DELL PERC S150 Configuration Utility](#).
2. Click **Controller Management > Convert to RAID Capable Disk**.
3. Select the RAID type.
  - NOTE:** RAID type will not be available if a RAID is already configured. To enable RAID type, convert the disk to a non RAID disk (see [Converting a physical disk to a Non-RAID disk](#)) and then convert them back to RAID capable disk.
4. Select disk interface type.
5. Select the physical disk to convert to a RAID capable disk. If you wish to select all the available disks, select **Check All**.
6. Click **Apply Changes** to submit the changes selected.

## Rescan disks

This option allows you to view the list of existing Physical and Virtual disks.

- NOTE:** The Rescan disks option may take from 10 to 20 seconds to display the list of disks, depending on the number of disks available in the system.

1. Enter the **Dell PERC S150 Configuration Utility**. See [Entering the DELL PERC S150 Configuration Utility](#).
2. Click **Controller Management > Rescan Disks**.  
The **Rescan Disks** screen is displayed. It provides information about the latest physical disk and virtual disk configurations.

## Virtual disk management

This section allows you to create, manage and delete virtual disks. You can also view and modify some properties of the associated physical disk.

### Configuring Windows RAID

- NOTE:** To enable RAID mode for NVMe PCIe SSDs, see [Setting the NVMe PCIe SSDs to RAID mode](#).

1. Enter the **Dell PERC S150 Configuration Utility**. See [Entering the DELL PERC S150 Configuration Utility](#).
2. Click **Controller Management→Convert to RAID Capable Disk**.
3. Select the RAID type **Windows RAID**.
4. Select the **Interface Type**.  
The options are SATA and NVMe.
5. Select the physical disk and click **Apply Changes**.  
A confirmation screen is displayed.
6. Click **Yes** to continue.
7. Click **Back** to return to the configuration options screen.
8. After converting the physical disks, click the **Virtual Disk Management** in the **Configuration Options** screen.
9. Click **Create Virtual Disks**.
10. Click **Select the Physical Disk**.
11. Select the interface type, media type, sector size, and the physical disks.
12. Click **Apply Changes**.
13. Enter the virtual disk size and select the **Virtual Disk Size Unit**.

- NOTE:** It is recommended to select the unit before specifying the disk size value. Changing the unit after entering the value may change the disk size.

14. Select the **Read Cache Policy**.
15. Select the **Write Cache Policy**.
16. Select the **Physical Disk Write Cache**.
17. Click **Create Virtual Disk**.  
The virtual disk is ready.

## Configuring Linux RAID

**NOTE:** The Linux RAID feature is supported on all the Sirius systems. To enable RAID mode for NVMe PCIe SSDs, see [Setting the NVMe PCIe SSDs to RAID mode](#) . For more information on installing SLES 15 see [SUSE Support](#).

1. Enter the **Dell PERC S150 Configuration Utility**. See [Entering the DELL PERC S150 Configuration Utility](#).
2. Click **Controller Management → Convert to RAID Capable Disk**.
3. Select the RAID type as **Linux RAID**.

**NOTE:** If the option to choose Linux RAID is disabled, convert the disk to a non-RAID disk (see [Converting physical disk to Non-RAID disk](#)) and then convert it back to RAID capable disk (see [Converting physical disk to RAID capable disk](#)).

4. Select the **Interface Type**. The options are SATA and NVMe.
5. Select the physical disk and click **Apply Changes**.  
A confirmation screen is displayed.
6. Click **Yes** to continue.
7. Click **Back** to return to the configuration options screen.
8. After converting the physical disks, click the **Virtual Disk Management** in the **Configuration Options** screen, and click **Create Virtual Disks**.
9. Select the required Linux operating system.

**NOTE:** If you select RHEL as the operating system, the entire physical disk space is used in the **Virtual Disk Size** field. With RHEL, you can create virtual disks only on the entire physical disk space.

**NOTE:** If you select SLES as the operating system, you can create virtual disks on both full and partial physical disk space.

10. Click **Select the Physical Disk**.
11. Select the interface type, media type, sector size, and the physical disks.
12. Click **Apply Changes**.
13. Click **Create Virtual Disk**.  
The virtual disk is ready.



## DELL EMC PERC S150 Configuration Utility

## Configuration Options • Controller Management • Convert to RAID Capable Disk

One or more Non-RAID disks have been detected in the system. Only RAID Capable physical disks can be used in a RAID configuration. Please select the Non-RAID Physical Disk(s) you would like to convert to RAID Capable Disk(s) from the list below.

Maximum allowed RAID Capable Disk(s) on a controller  
is: ..... 30  
Eligible Non-RAID Physical Disk(s) for conversion: .... 6

Select Physical Disk(s) to convert to RAID Capable Disk(s):

Select RAID Type: .....  Windows RAID  Linux RAID

Select Interface Type: .....  SATA  NVMe

- Physical Disk 0:0:0, NVMe, 2.91 TB, Non-RAID
- Physical Disk 0:1:0, NVMe, 3.63 TB, Non-RAID
- Physical Disk 0:0:1, NVMe, 2.91 TB, Non-RAID
- Physical Disk 0:1:1, NVMe, 1.81 TB, Non-RAID

 Converts Non-RAID physical disks to RAID capable physical disks.

PowerEdge R7525  
Service Tag : SSPTC63

Back

Figure 3. Convert to Linux RAID selection page

## Mixed RAID configuration

If your system detects mixed RAID configurations with both Windows and Linux RAID disks, then the S150 UEFI configuration utility displays the mixed configuration screen where you are encouraged to perform the following tasks:

1. To convert the Linux RAID disks:
  - a. In the WARNING: MIXED CONFIGURATION screen, select **Windows** RAID configuration.
  - b. Select the physical disks with Linux RAID configuration listed, and click the link **CONVERT TO NON-RAID**. If you do not want to convert the disks to non-RAID, remove the physical disks with Linux RAID configurations from the system.
2. To convert the Windows RAID disks:
  - a. In the WARNING: MIXED CONFIGURATION screen, select **Linux** RAID configuration.
  - b. Select the physical disks with Windows RAID configuration listed, and click the link **CONVERT TO NON-RAID**. If you do not want to convert the disks to non-RAID, remove the physical disks with Windows RAID configurations from the system.

 **NOTE:** The S150 controller does not support a mixed RAID configuration. If the mixed RAID configuration with both Windows and Linux RAID disks is detected, then you cannot perform any further tasks until you clear the physical disks or convert the physical disks.



## Manage virtual disk properties

The **Manage Virtual Disk Properties** screen allows you to modify the physical disk write cache policy and view the associated physical disk and its properties and policies.

In the **System Setup Main Menu**, click **Device Settings > Dell PERC S150 Configuration Utility > Virtual Disk Management > Manage Virtual Disk Properties**

The table explains the **Manage Virtual Disk Properties** screen details:

**Table 12. Virtual Disk Properties**

Menu Item	Description
Select Virtual Disk	Allows you to select the virtual disk from the drop-down menu
Virtual Disk Properties	Displays the ID, RAID Level, Status, Capacity, and the Sector Size of the virtual disk
Virtual Disk ID	Displays the ID for the virtual disk
RAID Level	Displays the RAID level of the virtual disk
Virtual Disk Status	Displays the virtual disk status
Virtual Disk Capacity	Displays the capacity of the virtual disk
Sector Size	Displays the sector size enabled for the virtual disk
Virtual Disk Policies	Displays the read and write cache policies of the virtual disk and the write cache policy of the associated physical disk
Read Cache Policy	Displays the read cache policies associated with the virtual disk
Write Cache Policy	Displays the write cache policies associated with the virtual disk
Physical Disk Write Cache	Displays the status of the physical disk write cache policy
Modify the Physical Disk Write Cache	Allows you to modify the physical disk write cache policy settings
 <b>NOTE:</b> If you have Linux RAID configured on the system, then you cannot modify any settings in this field.	
Physical Disk Write Cache	Allows you to change the physical disk write cache policy settings. The options are <b>Default</b> , <b>Enable</b> , and <b>Disable</b> .
 <b>NOTE:</b> If you have Linux RAID configured on the system, then you can only view the physical disk write cache setting	
Apply Disk Write Cache Settings	Allows you to apply the new write cache policy for the Physical disk.
View Associated Physical Disk	Clicking this link displays the physical disk that is associated with the selected virtual disk

## Viewing virtual disks properties and policies

The **View Virtual Disk Properties** screen allows you to view the virtual disk properties and the policies.

In the **System Setup Main Menu**, click **Device Settings > Dell PERC S150 Configuration Utility > Virtual Disk Management > View Virtual Disk Properties**

The table explains the **View Virtual Disk Properties** screen details:

**Table 13. View Virtual Disk Properties**

Menu Item	Description
Select Interface Type	Allows you to select the disk interface type. The options are <b>SATA</b> and <b>NVMe</b>
Select Virtual Disk	Allows you to select the virtual disk from the drop-down menu
 <b>NOTE:</b> Virtual disks in failed status are only listed in <b>Manage Virtual Disk Properties</b> screen.	

**Table 13. View Virtual Disk Properties (continued)**

Menu Item	Description
Virtual Disk Properties	Displays the ID, RAID Level, Status, Capacity, and the Sector Size of the virtual disk
Virtual Disk ID	Displays the virtual disk ID
RAID level	Displays the RAID level associated with the virtual disk
Virtual Disk Status	Displays the status of the virtual disk
Virtual Disk Capacity	Displays the capacity of the virtual disk
Sector Size	Displays the sector size enabled
Virtual Disk Policies (SATA drives only)	Displays the read and write cache policies of the virtual disk and the write cache policy of the associated physical disk
Read Cache Policy (SATA drives only)	Displays the read cache policies associated with the virtual disk
Write Cache Policy (SATA drives only)	Displays the write cache policies associated with the virtual disk
Physical Disk Write Cache (SATA drives only)	Displays the physical disk which is associated with the specific virtual disk
Associated Physical Disks	Displays the associated physical disk's properties

## Deleting a virtual disk

1. Enter the **Dell PERC S150 Configuration Utility**. See [Entering the DELL PERC S150 Configuration Utility](#).
2. Click **Virtual Disk Management** > **Select Virtual Disk Operations**.
3. Select a virtual disk that you want to delete from the drop-down menu.
4. Click **Delete Virtual Disk**.
5. Select **Confirm** and click **Yes** to continue.  
The selected virtual disk is deleted.

**NOTE:** When a degraded or a failed virtual disk from one system is added to another system, and if the number of virtual disks exceeds the maximum limit of 30, you cannot delete the virtual disks that are in the **Normal** or **Ready** state.

## Physical disk management

You can view, select, and manage physical disks.

**NOTE:** NVMe PCIe SSDs may not be sorted by slot number or ID in the physical disk list.

**NOTE:** Physical disk capacity that is displayed may be lower than the actual capacity.

## Viewing physical disk properties

You can view the properties of the physical disks and also view the details of the associated virtual disks in the **View Physical Disk Properties** screen.

In the **System Setup Main Menu**, click **Device Settings** > **Dell PERC S150 Configuration Utility** > **Physical Disk Management** > **View Physical Disk Properties**

The table explains the **View Physical Disk Properties** screen details:

**Table 14. View Physical Disk Properties**

Menu Item	Description
Select Interface Type	Allows you to select the disk type, the options are <b>SATA</b> and <b>NVMe</b> .

**Table 14. View Physical Disk Properties (continued)**

Menu Item	Description
Select Physical Disk	Allows you to select the physical disks from the drop-down menu.
Physical Disk Properties	Displays information about the physical disk properties.
Physical disk ID	Displays the ID of the physical disk.
Form Factor	Displays the form-factor of the physical disk.
State	Displays if it is a RAID capable disk or a Non-RAID disk.
Size	Displays the total storage space of the physical disk.
SMART status	Displays if the SMART feature is enabled or disabled for the physical disk.
Revision	Displays the revision.
Device Type	Displays the device type.
Certified (SATA Drives only)	Displays if the physical disk is Dell certified or not.
Connector Port (SATA Drives only)	Displays the port number in which the SATA physical disk is installed.
Disk Write Cache (SATA Drives only)	Displays if the disk cache is enabled or disabled.
Hot Spare	Displays if the physical disk is assigned as a hot spare.
Available Space	Displays the free space of the respective physical disk.
Used Space	Displays the used space of the respective physical disk.
Device Protocol	Displays if the protocol of the physical disks.
Media Type	Displays the type of disk selected.
Disk Sector Size	Displays the type of sector size enabled.
Negotiated Physical Disk Transfer speed (SATA Drives only)	Displays the speed at which the data is transferred.
Dell Part Number	Displays the part number of the SATA physical disk. Part number is not displayed for NVMe disks.
Serial Number of Disk	Displays the serial number of the physical disk.
Hardware Vendor	Displays the information about the hardware vendor. <i>i</i> <b>NOTE:</b> Displays <b>Unknown</b> option, when a Toshiba NVMe drive is connected. <i>i</i> <b>NOTE: Hardware Vendor</b> may be truncated or missing in the OPRM window due to a limitation in the OPRM GUI design.
Model Number	Displays the model number of the physical disk. <i>i</i> <b>NOTE:</b> Model number may appear truncated in the OPRM Window.
Manufacturing Date	Displays the manufacturing date of the physical disk.
Associated Virtual Disks	Displays the disk ID, RAID level, size and status of the associated virtual disk.

## Managing the physical disk write cache policy for SATA drives

Perform the following procedure to enable the physical disk write cache policy:

1. Enter the **Dell PERC S160 Configuration Utility**. See [Entering the DELL PERC S160 Configuration Utility](#).
2. Click **Physical Disk Management** → **Select Physical Disk Operations**.
3. Click the link **Manage Physical Disk Properties**.  
The **Manage Physical Disk Properties** screen is displayed.
4. Select one or multiple physical disk to apply the write cache policy.
5. Choose from the following physical disk write cache policies:

<b>Default</b>	The physical disk write cache feature is enabled for the physical disk write cache feature is disabled for 6 Gbps HDDs <ul style="list-style-type: none"> <li>• SSDs</li> <li>• 3 Gbps HDDs</li> </ul>
<b>Enable</b>	The feature is enabled on the disk selected.
<b>Disable</b>	The feature is disabled on the disk selected.

6. Click **Apply** to save the changes made.

 **NOTE:** Ensure that you change the physical disk write cache policy of a global hot spare disk after rebuild to the write cache policy of the last configured virtual disk.

 **NOTE:** In the **View Virtual Disk Properties** screen, ensure that the physical disk write cache setting is consistent across the physical disk associated with the virtual disk.

 **NOTE:** If you have Linux RAID configured on the system, you cannot modify the physical disk write cache policy feature settings.

 **NOTE:** For more information about the physical disk write cache behavior, see the [Troubleshooting your system](#) section.

## Assigning the global hot spare

1. Enter the **Dell PERC S150 Configuration Utility**. See [Entering the DELL PERC S150 Configuration Utility](#) .
2. Click **Physical Disk Management > Select Physical Disk Operations**.
3. Select the physical disk that is in the ready state from the drop-down menu.
4. Click the link **Assign Global Hot Spares**.

 **NOTE:** A global hot spare disk cannot be created if you have Linux RAID configured on the system.

## Unassign a global hot spare

 **NOTE:** Unassigning a hot spare may place the data at risk in the event of a disk failure.

1. Enter the **Dell PERC S150 Configuration Utility**. See [Entering the DELL PERC S150 Configuration Utility](#).
2. Click **Physical Disk Management > Select Physical Disk Operations**.
3. Select a global hot spare disk from the drop-down menu.
4. Click the link **Unassign Hot Spare**.  
Confirmation screen appears.
5. Click **Yes** to confirm.

## Assigning the dedicated hot spare

 **WARNING:** Assigning a disk as a hot spare will cause the data on the disk to be permanently deleted.

 **NOTE:** After a hot spare rebuild, creating new partial virtual disk on the same Linux RAID disk is not supported.

1. Enter the **Dell PERC S150 Configuration Utility**. See [Entering the DELL PERC S150 Configuration Utility](#).
2. Click **Virtual Disk Management > Manage Virtual Disk Properties**.
3. Select the virtual disk that is in the ready state from the drop-down menu.
4. Click **Manage Dedicated Hot Spares**
5. Select the physical disk that you want to be assigned as a dedicated hot-spare disk.
6. Click the link **Add Hot Spare Disk**.  
Confirmation screen appears.
7. Select **Confirm** and click **YES** to complete the dedicated hot spare disk assignment.

## Cryptographic erase

 **WARNING:** Performing a cryptograph erase, causes permanent loss of data.

 **NOTE:** Cryptographic erase is only supported on NVMe PCIe SSDs and ISE-capable SATA drives.

1. Enter the **Dell PERC S150 Configuration Utility**. See [Entering the DELL PERC S150 Configuration Utility](#).
2. Click **Physical Disk Management** → **Select Physical Disk Operations**.
3. Select the Interface Type.  
The options are SATA and NVMe.
4. Select the physical disk from the drop-down menu.
5. Click **Cryptographic Erase**.
6. Click **Yes** to start the cryptographic erase.

## Viewing global hot spares

The **View Global Hot Spares** screen displays the physical disk assigned as global hot spare.

In the **System Setup Main Menu**, click **Device Settings** > **Dell PERC S150 Configuration Utility** > **Physical Disk Management** > **View Global Hot Spares**

# Installing the drivers

The PERC S150 requires software drivers to operate with supported operating systems. Which drives to install depends on the type of the system and the operating system installed.

 **NOTE:** To check operating system compatibility, see [Operating Systems Manuals](#).

 **NOTE:** If the operating system is installed on a PERC or BOSS device, ensure that the software RAID OS driver is installed using the Dell Update Package (DUP) while SATA and NVMe are in RAID mode in BIOS settings.

 **NOTE:** SWRAID driver installation through life cycle controller is not supported.

## Topics:

- [Pre-installation requirements](#)
- [Creating the device driver media for Windows driver installation](#)

## Pre-installation requirements

Before you install the operating system:

- Read the Microsoft Getting Started document that shipped with your Windows operating system.
- Ensure that your system has the latest BIOS, firmware, and driver updates. If required, download the latest BIOS, firmware, and driver updates from [Dell Support Site](#).
- Create a device driver media (USB drive, CD, or DVD).

## Setting the SATA controller to RAID mode

1. Turn on the system.
2. When the **Dell Power-On Self-Test (POST)** screen is displayed, press F2.
3. When the **Dell PowerEdge System** window is displayed, scroll to **SATA Settings** and press Enter. In the sub-screen, confirm that the **SATA Controller** is set to a RAID mode.

 **NOTE:** If necessary, use the space bar to change the setting.

4. Press Esc to exit.
5. Press Esc again.

## Setting the NVMe PCIe SSDs to RAID mode

To use PERC S150 on NVMe PCIe SSD, change the settings of NVMe PCIe SSDs to RAID mode in BIOS HII.

 **WARNING:** Changing to RAID mode may cause a data loss in the NVMe PCIe SSD.

 **NOTE:** Ensure SATA settings is on RAID mode.

1. Turn on the system.
2. When the **Dell Power-On Self-Test (POST)** screen is displayed, press F2.
3. When the **System Setup** window is displayed, click **System BIOS**.
4. Click **NVMe Settings**.
5. Select the **NVMe Mode** as **RAID** mode.
6. Select the **BIOS NVMe Driver** as **Dell Qualified Drives** or **All Drives**.

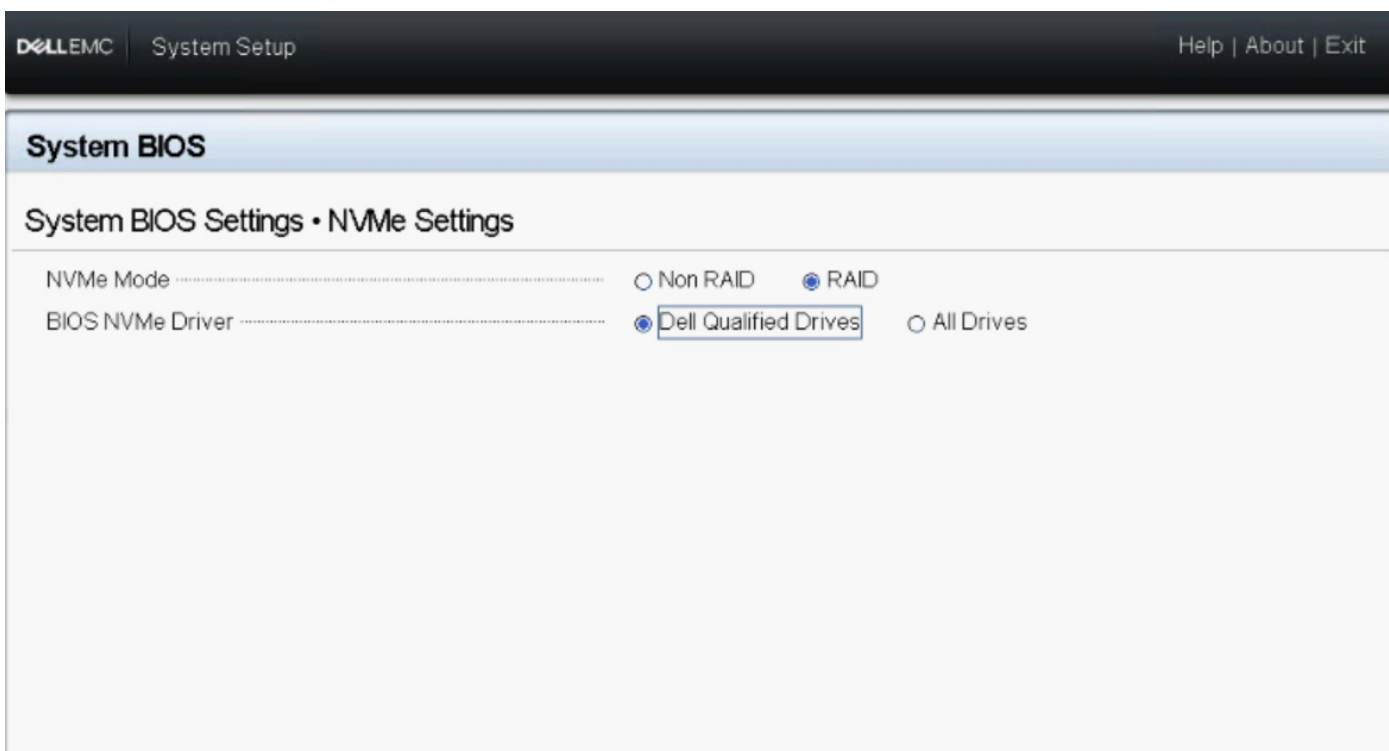

**Figure 4. NVMe Settings in BIOS**

- NOTE:** If you change the NVMe Mode setting from RAID to Non RAID, ensure that the NVMe driver (Microsoft or third-party NVMe driver) is installed manually in the Windows environment.
- NOTE:** When the default **Dell Qualified Drives** is selected as **BIOS NVMe Driver**, PERC S150 driver is loaded only for the DELL certified NVMe drives.
- NOTE:** If **All Drives** is selected, PERC S150 driver is loaded for both DELL certified NVMe drives and Non-Dell certified NVMe drives.
- NOTE:** After the OS is installed, if **NVMe Mode** or **BIOS NVMe Driver** is changed, the changes are not reflected in the OS environment.
- NOTE:** If **Non RAID** mode is selected on a SATA+NVMe configured system (with NVMe drives), UEFI0116 error is displayed in the console during the intermediate reboot of Windows Server operating system installation.
- NOTE:** If **Non RAID** mode is selected on a SATA+NVMe configured system (with NVMe drives), UEFI0116 error is displayed in the console when the system is rebooted after Linux operating system installation and before the completion of resync.

7. Click **Back**.
8. Click **Finish**.

## Creating a virtual disk

For more information about creating a virtual disk, see [Creating the virtual disks](#).

## Checking PERC S150 options and the boot list priority

1. In the **Virtual Disks** field, ensure the bootable virtual disk is the first virtual disk listed. If the bootable virtual disk is not the first virtual disk listed, see [Swapping two virtual disks](#).



**NOTE:** If Non-RAID virtual disks are used (and appear in the Virtual Disks list), the **Swap Two Virtual Disks** option is enabled only if the system contains a RAID Capable physical disk.

2. Select **Continue to Boot** and press Enter.

## Creating the device driver media for Windows driver installation

### Downloading drivers for PERC S150 from the Dell support website for all operating systems

1. Go to [Supported Drivers](#).
2. In the **Product Selection** section, enter the service tag of your system in the **Service Tag or Express Service Code** field.

**NOTE:** If you do not have the service tag, select **Automatically detect my Service Tag for me** to allow the system to automatically detect your service tag, or select **Choose from a list of all Dell products** to select your product from the **Product Selection** page.

3. Select the **Operating System**, **Category**, **Release Date**, and **Importance** from the respective drop-down lists. The drivers that are applicable to your selections are displayed.
4. Download the drivers that you require to a USB drive, CD, or DVD.
5. During the operating system installation, use the media that you created with the **Load Driver** option to load mass storage drivers. For more information on reinstalling the operating system, see the operating system document at [Operating Systems Manuals](#).

**NOTE:** For systems with NVMe PCIe SSD, ensure the S150 driver is installed to discover the RAID disk in your operating system environment.

**NOTE:** During the Windows OS installation using the onboard optical disk drive, while loading the S150 driver, a warning message may appear: **No new device drivers were found. Make sure the installation media contains the correct drivers when SATA is in RAID mode.** Perform the following steps to proceed with the installation:

- a. Click **OK**.
- b. Close the warning window.
- c. Click **Install Now**, and follow the instructions on the screen.

### Downloading drivers from the Dell Systems Service and Diagnostic Tools media for Windows

1. Insert the Dell Systems Service and Diagnostics Tools media in your system. The **Welcome to Dell Service and Diagnostic Utilities** screen is displayed.
2. Select your system model and operating system. For the list of supported operating systems, see [Supported operating systems](#).
3. Click **Continue**.
4. From the list of drivers displayed, select the driver you require.
5. Select the self-extracting zip file and click **Run**.
6. Copy the driver to a CD, DVD, or USB drive. Repeat this step for all the drivers you require.
7. During the operating system installation, use the media that you created with the **Load Driver** option to load mass storage drivers. For more information on reinstalling the operating system, see the relevant section for your operating system.

## Accessing ZP files

1. Download the ZP file. The downloaded file will be with extension **.exe**.
2. Rename the file extension to **.zip**.
3. Extract the content.

The driver files will be visible in the extracted folder. The driver can be installed by right clicking the **.inf** file.

 **NOTE:** S150 I/O driver name is bcraid <xyz>.sys, where xyz is the first three digits of the driver version. For example, if the version is 6.0.3.0007, driver name is bcraid603.sys.

# Troubleshooting your system

To get help with your PERC S160 or PERC S150 controllers, you can contact your Dell Technical Service representative or see [Dell Support Site](#)..

## Topics:

- [Precautions for hot removal or hot insertion of NVMe drives](#)
- [Unable to configure Linux RAID using UEFI Configuration Utility](#)
- [Performance degradation after disabling SATA physical disk write cache policy](#)
- [Unable to modify any feature settings in UEFI or OPROM](#)
- [Extra reboot during OS installation](#)
- [OS installation failing on NVMe PCIe SSD with third-party driver](#)
- [Server performance is slow and crashes during OS installation on the SATA configuration](#)
- [Server performance is slow during OS installation on the NVMe configuration](#)
- [System startup issues](#)
- [The BIOS configuration utility option does not display](#)
- [Configuring RAID using the ROM utility option is disabled](#)
- [Warning Messages](#)
- [Other errors appearing on the BIOS screen](#)
- [Physical disk - related errors](#)
- [Virtual disks - related errors](#)
- [S150 config driver is not installed after S150 DUP is run](#)
- [S150 driver not identifying P4800 drives](#)
- [S150 DUP update message is displayed only for SATA controllers](#)

## Precautions for hot removal or hot insertion of NVMe drives

**Corrective Action:** If you are performing multiple hot-plug operations a minimum of 30 seconds is required before performing any hot removal or hot insertion operation, and Open manage storage services (OMSS) should reflect each performed hot removal or hot insertion operation before performing the next hot removal or hot insertion.

## Unable to configure Linux RAID using UEFI Configuration Utility

**Likely Cause:** Option to select Linux RAID in **Configuring Linux RAID** page will be disabled if RAID is already configured.

**Corrective Action:** To resolve this issue:

1. If applicable, delete the virtual disk created in Windows RAID.
2. Convert physical disk to Non-RAID disk. See [Converting physical disk to Non-RAID disk](#).
3. Convert physical disk to RAID. See [Converting physical disk to RAID capable disk](#).
4. Configure Linux RAID. See [Configuring Linux RAID](#)

## Performance degradation after disabling SATA physical disk write cache policy

**Likely Cause:** Disk write operations can cause degradation in performance.

**Corrective Action:** To resolve this issue, enable the physical disk write cache policy.

**NOTE:** Ensure that there is constant power supply to the system (A UPS is recommended).

**NOTE:** If you create a virtual disk using Dell LifeCycle controller, then the physical disk write cache policy is set to default. For more information about the physical disk write cache policy behavior, see the [Managing the physical disk write cache policy for SATA drives](#) section.

## Unable to modify any feature settings in UEFI or OPRM

**Likely cause:** You cannot modify the settings in UEFI or OPRM if the number of virtual disks exceeds than 30.

**Corrective Action:** To resolve this issue:

1. Start the operating system.
2. Use OpenManage to ensure that the maximum number of virtual disks does not exceed 30.

## Extra reboot during OS installation

**Description** The system may reboot one extra time during the OS installation using driver-injection method.

**Likely Cause:** SATA in RAID mode and NVMe in non-RAID mode may cause an extra reboot on system with NVMe PCIe SSDs during OS installation.

## OS installation failing on NVMe PCIe SSD with third-party driver

**Likely Cause:** Using third-party driver for NVMe PCIe SSD while NVME mode is set to RAID may cause the OS installation to fail.

**Corrective Action:** Third-party drivers for NVMe PCIe SSDs are not supported in NVMe in RAID mode.

## Server performance is slow and crashes during OS installation on the SATA configuration

**Likely Cause:** One or more SAS drives is connected along the SATA drives in the server.

**Corrective Action:** Disconnect the SAS drives connected to the server. SAS drives is not supported on the SATA configuration.

# Server performance is slow during OS installation on the NVMe configuration

**Likely Cause:** One or more SAS drives is connected to the server on the NVMe configuration.

**Corrective Action:** Disconnect the SAS drives connected to the server.

## System startup issues

To troubleshoot system startup issues, review the following:

### System does not boot

Check for the following causes when the system does not boot:

- Incorrect **Controller Mode** at the **System Setup**.
- Incorrect **Boot Mode**, **Boot Sequence**, and/or **Boot Sequence Retry**.
- Bootable virtual disk is in **Failed** state.
- Incorrect **Boot Order** for a bootable virtual disk.
- A Non-RAID virtual disk is no longer in the first position in the BIOS Configuration Utility Ctrl+R list after the system is rebooted.
- In a Linux RAID configuration, if virtual disks created exceeds the maximum limit of 30 and the boot virtual disk is not listed as one of the 30 virtual disks in UEFI configuration utility.
- In a Linux RAID configuration, if the virtual disk is created from the drives beyond the first 10 drives listed in the S150 UEFI HII.

### Controller mode is set incorrectly at system setup

1. In the system startup, when the **Dell Power-On Self-Test (POST)** screen is displayed, press F2 to enter the system BIOS screen.
2. Scroll to **SATA Settings**. Press Enter and ensure that the **SATA Controller** is set to RAID mode.

 **CAUTION: Switching from RAID Mode to ATA Mode or AHCI Mode may lead to data loss and unpredictable behavior.**

### Boot mode, boot sequence, and or boot sequence retry are set incorrectly

1. Turn on the system.
2. When the Dell **POST** screen is displayed, press F2 to enter the system BIOS screen.
3. Scroll to **Boot Settings**. Press Enter and ensure that **Boot Mode** is set to **BIOS**.
4. Scroll to **Boot Sequence**. Press Enter and ensure that **Hard drive C:** is the first device listed.
5. Scroll to **Boot Sequence Retry**. Ensure that the setting is **Enabled**.
6. Press Esc to exit and continue booting.

 **NOTE:** If changes are made at the BIOS screen, a dialog box is displayed and asks you to save your changes and then exit.

## Bootable virtual disk is in a failed state

1. Press Ctrl+Alt+Del to restart.
2. After the system restart, press Ctrl+R. Check the status of the bootable virtual disk at the **Virtual Disk** field, or by highlighting **View Virtual Disks Details** and pressing Enter.
3. Check for missing or offline physical disks.

## The boot order is incorrect for a bootable virtual disk

1. When prompted at system startup, press Ctrl+R to access the system BIOS configuration utility.
2. Check **Virtual Disks** and ensure that the bootable virtual disk is the first virtual disk listed.
3. If required, use the **Swap Two Virtual Disks** option to reposition the virtual disks.

## A Non-RAID virtual disk is no longer in first position in the BIOS configuration utility list after a system reboot

**NOTE:** When booting from a Non-RAID virtual disk, creating a virtual disk in OpenManage Server Administrator changes the virtual disk order and displaces the bootable Non-RAID virtual disk from the first position. PERC S150 then attempts to boot from the first virtual disk.

**NOTE:** A Non-RAID virtual disk can be created from Non-RAID physical disks—which are physical disks initialized by a controller other than PERC S150.

1. When prompted at system startup, press Ctrl+R to access the BIOS configuration utility.
2. Check Virtual Disks and determine if the bootable Non-RAID virtual disk is no longer in the first position.
3. Use the **Swap Two Virtual Disks** option to swap the virtual disks and place the bootable Non-RAID virtual disk in the first position of the **Virtual Disks** field.

## The BIOS configuration utility option does not display

The **BIOS configuration utility Ctrl+R** option does not display if the PERC S150 mode is set incorrectly in the system BIOS. For the correct **SATA Setting**, see [Controller mode is set incorrectly at system setup](#).

## Configuring RAID using the ROM utility option is disabled

Use the **PERC S150 Configuration Utility** to configure RAID on systems with NVMe PCIe SSDs.

## Warning Messages

The **Dell Inc. PERC S150 Controller system BIOS** screen is one of the first screens to appear during your system's boot sequence. If the system's virtual disks were in **Normal** or **Ready** status before a system boot, the boot sequence continues normally to the Microsoft Windows Server operating system. But, if a virtual disk is in **Degraded** or **Failed** status, or if specific options in the **Controller Options** field were changed previously at the **BIOS Configuration Utility (<Ctrl><R>)**, the following warning messages appear during the boot sequence.

## WARNING- Found virtual disks that are degraded

The following message is displayed after the warning is displayed: --- Press Enter to continue, or Ctrl+R to enter setup ---.

This warning message is displayed when at least one virtual disk is in a **Degraded** state and **Pause if Degraded** is set to **ON** at the **BIOS Configuration Utility Ctrl+R**.

Press Enter to allow the operating system to continue with the boot sequence, or press Ctrl+R to enter into the **BIOS Configuration Utility Ctrl+R** to investigate the cause of the **Degraded** virtual disk.

To investigate the cause, check for the following:

- Whether a physical disk in the virtual disk has failed or has gone offline. Check the status at the **Physical Disks** field. A **Degraded** status depends on the RAID level of the virtual disk and the number of physical disks that have failed:
  - For a virtual disk at RAID 1 or RAID 5, a single physical disk failure causes a **Degraded** status.
  - For a virtual disk at RAID 10, the failure of a physical disk in each of the mirror sets creates a **Degraded** status for the RAID 10. The failure of two physical disks in the same mirror set creates a **Failed** status for the RAID 10.
- Whether the controller has failed due to a firmware failure or a component failure. A failed controller causes a virtual disk not to boot.

For the virtual disk to recover from **Degraded** status, the failed physical disk must be replaced and the virtual disk must be rebuilt using OpenManage Server Administrator Storage Management. When the rebuild operation is completed, the virtual disk status changes from **Degraded** to **Ready**. For a description of the rebuild function, see Storage Management at [Manuals](#).

## WARNING - Found virtual disks that are failed

This warning message is displayed when at least one virtual disk is in a **Failed** state and **Pause if Failed** is set to **ON** at the **BIOS Configuration Utility (<Ctrl><R>)**.

The following message is displayed after the warning is displayed: --- Press <Enter> to continue, or <Ctrl><R> to enter setup --- .

Press <Enter> to allow the operating system to continue its boot, or press <Ctrl><R> to enter into the **BIOS Configuration Utility (<Ctrl><R>)** to investigate the cause of the **Failed** virtual disk.

 **NOTE:** A boot virtual disk that is in a **Failed** state prevents the operating system from booting.

To investigate the cause, check for the following:

- Determine if a single or multiple physical disks in a non-redundant virtual disk have failed. If **yes**, data is lost. Recover the lost data from a backup storage source.
- Determine if two or more physical disks in a redundant virtual disk have failed. If **yes**, data is lost. Recover the lost data from a backup storage source.

 **NOTE:** For a RAID 10 configuration, if a single physical disk fails in each mirrored set, the redundant virtual disk goes to a **Degraded** status but data is not lost. If two physical disks fail in one of the mirrored sets, the redundant virtual disk goes to a **Failed** status and data is lost.

## WARNING - Found virtual disks that are degraded and failed

This warning message is displayed when multiple virtual disks are in **Degraded** and **Failed** state and **Pause if Degraded** or **Pause if Failed** are set to **ON** at the **BIOS Configuration Utility Ctrl+R**.

The following message is displayed after the warning is displayed: --- Press Enter to continue, or Ctrl+R to enter setup --- .

Press <Enter> to allow the operating system to continue its boot, or press Ctrl+R to enter into the **BIOS Configuration Utility Ctrl+R** to investigate the cause of the **Degraded** and **Failed** virtual disks.

 **NOTE:** A boot virtual disk that is in a **Failed** state prevents the operating system from booting.

To investigate the cause, check for the following:

- Whether the virtual disk is in **Degraded** status because one of the physical disks of a RAID 1 or RAID 5 virtual disk has failed, or one of the physical disks of a RAID 10 virtual disk has failed. Press Ctrl+R and verify if the physical disks are offline or

missing. Remove and replace a failed physical disk. A second physical disk failure could cause a **Degraded** virtual disk to change to **Failed** status.

- Whether the virtual disk is in a **Failed** status because one or more of the physical disks have failed. Press Ctrl+R and verify if the physical disks are offline or missing. Remove and replace the failed physical disk or disks.

## Other errors appearing on the BIOS screen

### BSOD is observed while booting on the NVMe configuration server

- Description:** NVMe drives utilize the system resources, if more number of NVMe drives is connected to a server having less number of cores, then there is a lack of resources to service the NVMe and BSOD can occur.
- Corrective action:** Ensure **logical processor** is enabled under **BIOS HII > Processor Settings** or remove some of the NVMe drives before booting and hot insert the drives after booting.

### S150 controller lists M.2 drives

- Description:** In RAID mode, M.2 drives mapped to onboard SATA controller are claimed by the S150 controller.
- Corrective action:** This is an expected behavior and no action is required.

### Error in displaying the CD/DVD-ROM while in legacy mode

- Description:** The maximum number of virtual disks supported in legacy BIOS mode is 10. The user will not be able to view CD/DVD-ROM in the BIOS **One Shot Boot Menu** if the number of virtual disks exceeds 10.
- Corrective action:** Delete virtual disks so that the number of virtual disks does not exceed 10.

### Unavailable error under UEFI boot settings

- Description:** In an NVMe configuration **Embedded RAID controller 2** is unavailable under UEFI boot settings.
- Likely cause:** This is an expected behaviour in an NVMe configuration only and not in a SATA configuration. This error can be ignored as there is no functionality loss.

### S150 does not display greater than ten virtual disks in the BIOS Configuration Utility or CTRL R

- Likely Cause:** The function is not supported.
- Corrective Action:** Remove all physical disks except for the last one(s) added. Then proceed with deleting the virtual disks that are not needed. Remember to take account of the virtual disks that are currently being used.

### Unable to delete virtual disks when there are more than 30 virtual disks present in the system

- Likely cause:** The function is not supported.



**Corrective Action:** Remove all physical disks except for the last one added. Then proceed with deleting the virtual disks that are not needed. Remember to take account of the virtual disks that are currently being used.

## Virtual disk rebuild status in the BIOS Configuration Utility (<CTRL><R>) or in UEFI HII

**Likely Cause:** Rebuild is not supported in the **BIOS Configuration Utility (<CTRL><R>)** or in **UEFI HII** mode.

**Corrective Action:** Boot to a supported operating system. Rebuild starts. To view rebuild status, install a supported storage application.

## Physical disk - related errors

- The physical disk fails
- Cannot initialize a physical disk
- Status LED is not working
- Cannot update NVMe PCIe SSD firmware by using Dell Update Package or DUP
- Third-party driver installation for NVMe PCIe SSD failing
- Unable to find the NVMe PCIe SSD for operating system installation

### The physical disk fails

If the physical disk fails, check the following causes:

- A physical disk is not visible in the BIOS Configuration Utility or is offline.
- A physical disk is highlighted red at the BIOS Configuration Utility or Ctrl R.

### A physical disk is not visible in the BIOS Configuration Utility or is offline

1. Check that the cables are properly connected.
2. Check that the physical disk is installed properly in the system's backplane.
3. Check the system's backplane for damage.
4. Reinstall the physical disk and ensure that it is seated correctly in the system's backplane.
5. Check if the Physical Disk might be a SAS drive.
6. Perform a Rescan, to perform either of the following:
  - a. Update the status of storage devices attached to the controller.
  - b. Fix an error caused by deleting or initializing a virtual disk.

### A physical disk is highlighted red at the BIOS Configuration Utility or Ctrl R

1. Replace the physical disk. Depending on the RAID level of the virtual disk, data might be lost.
2. Perform a **rescan** to confirm that the new disk was discovered.

### Cannot initialize a physical disk

Check whether or not the physical disk is:

1. Already a member of a virtual disk.
2. Currently a global or dedicated hot spare.
3. Reporting an **Offline** state.  
Only physical disks that are **Ready** state can be initialized.

## Status LED is not working

Ensure system is booted to the operating system. Install **Open Manage Server Administrator** management utility version 8.0 (or higher).

## Behavior of a faulty drive is undefined

A faulty drive does not respond to commands.

A faulty drive may not respond to Admin and IO commands. Therefore, a failure may be indicated for the following commands:

- The `identify` command
- The `export log` command
- The IO commands

## Cannot update NVMe PCIe SSD firmware by using Dell Update Package or DUP

- Likely Cause:** The supported device driver for the operating system on your system is not installed.
- Corrective Action:** Before you update the NVMe PCIe SSD firmware using DUP, ensure that the required device driver for the operating system available on your system is installed.

## NVMe drive error when inserted for the first time

- Description:** When the NVMe drive is inserted for the first time, it displays **Standard NVMe Controller** in device manager, and not as **DELL PERC S150 CONTROLLER**.
- Solution** Run the supported S150 DUP executable.

## Third-party driver installation for NVMe PCIe SSD failing

- Description:** While NVMe mode is set to RAID and operating system installation is complete, installing a third-party driver for NVMe PCIe SSD may fail.
- Solution** Third-party drivers for NVMe PCIe SSDs are not supported with NVMe in RAID mode.

## Unable to find the NVMe PCIe SSD for operating system installation

- Likely Cause:** S150 drivers are installed while NVMe is in non-RAID mode.
- Corrective Action:** Ensure that NVMe is in RAID mode before installing S150 driver.

## Virtual disks - related errors

- Stale partitions are listed on creating a virtual disk for Linux
- Rebuilding a virtual disk the global hot spare is not listed as online in HII or iDRAC
- S150 displays 22 virtual disks on POST instead of 30 virtual disks
- S150 displays 43 virtual disks on POST instead of 30 virtual disks
- Display of failed virtual disk in HII

- Virtual disk size in decimals is not supported while creating a VD
- Cannot create a virtual disk
- A virtual disk is in a degraded state
- Cannot assign a dedicated hot spare to a virtual disk
- Cannot create a global hot spare
- A dedicated hot spare fails
- Failed or degraded virtual disk
- Cannot create a virtual disk on selected physical disks
- RAID disk created from the NVMe PCIe SSDs not appearing in operating system environment, showing as partitioned disks
- Cannot perform an online capacity expansion or reconfigure on a virtual disk
- Unable to configure RAID on NVMe PCIe SSD using a third party RAID configuration utility

## Stale partitions are listed on creating a virtual disk for Linux

**Description:** When a virtual disk is created using physical disks that were earlier used for creating Linux virtual disk, some Linux partitions are present during operating system installation.

**Solution** When you create or delete a virtual disk, only the superblock metadata is modified. The partition table of the virtual disk that is stored at logical LBA-0 is not modified. Hence, when you re-create a virtual disk, the previous partitions are still listed.

- During operating system installation, these partitions can be deleted using the operating system installer.
- To not list the partitions, if supported you can perform cryptographic erase of the physical disk and then create a virtual disk from the HII.

 **NOTE:** Performing cryptographic erase deletes all the data on the physical disks.

 **NOTE:** In the **Non RAID** mode, if the NVMe disks (that were earlier used to create VDs) are reused without deleting the metadata, the Linux Installer still detects the VDs.

## Rebuilding a virtual disk the global hot spare is not listed as online in HII or iDRAC

**Description:** After the rebuild of a virtual disk is completed using the global hot spare the status of the disk is not listed as online, instead the status of the disk is listed as ready.

**Solution** This is an expected behavior. No action is required.

## S150 displays 22 virtual disks on POST instead of 30 virtual disks

**Description:** The maximum number of virtual disks that are supported in OPROM is 24.

- If the physical disks are connected, only 22 virtual disks are displayed.
- If an optical drive is connected, and a DVD disk is inserted into the optical drive, then 23 virtual disks are displayed.
- If two optical drives with DVD disks inserted into the optical drives are connected, then 24 virtual disks are displayed.

**Corrective action:** This is an expected behavior and no action is required.

## S150 displays 43 virtual disks on POST instead of 30 virtual disks

**Description:** The maximum number of virtual disks that are supported in UEFI is 30.

- You cannot create more than 30 virtual disks.

- During virtual disk management and re-scan operations, you can see only 30 virtual disks. This is an expected behavior.
- If a drive or drives with virtual disks are imported from another system, then 43 virtual disks are displayed.

**Corrective action:** This is an expected behavior and no action is required.

## Display of failed virtual disk in HII

**Description:** If any failed virtual disk is present in the system, then it is not listed under **View Virtual Disk Properties**. The failed virtual disk is listed under **Select Virtual Disk Operations** and **Manage Virtual Disk Properties**.

**Corrective Action:** This is an expected behavior and no action is required.

## Virtual disk size in decimals is not supported while creating a VD

**Likely Cause:** After entering the disk size value, changing the virtual disk size unit from MB to GB or GB to TB and so on changes the disk size value.

**Corrective Action:** It is recommended to select the virtual disk size unit before specifying the disk size value.

## Cannot create a virtual disk

If you are unable to create a virtual disk, check the following causes:

1. [The physical disk is not displayed.](#)
2. [Insufficient free space available on the selected physical disks.](#)
3. [Incorrect number of physical disks selected for the desired RAID level .](#)
4. [The desired physical disk is unavailable.](#)
5. [The system already has a maximum of 30 virtual disks.](#)

### The physical disk is not displayed

This error might be because:

1. The controller cannot communicate with the physical disks.
2. A cable might be loose or defective.
3. The physical disk might be a SAS drive.  
Re-seat the physical disks in the backplane and check their cables.

### Insufficient free space available on the selected physical disks

There must be sufficient available free space on the physical disk used by the virtual disk.

### Incorrect number of physical disks selected for the desired RAID level

For details about RAID levels and the allowable number of physical disks used with each RAID level, see understanding RAID levels in *RAID Technology Guide* at [Manuals](#).

### The desired physical disk is unavailable

Determine whether the physical disk:

1. Is a dedicated hot spare and unavailable for use in another virtual disk.

2. Is full or has insufficient available capacity.

## The system already has a maximum of 30 virtual disks

Delete unused virtual disks.

 **CAUTION:** Deleting a virtual disk destroys all data on the virtual disk.

## A virtual disk is in a degraded state

If the virtual disk is in a degraded state, check the following causes:

1. A physical disk was removed.
2. Physical or mechanical problems with the physical disk.
3. The virtual disk has lost redundancy.
4. Corrupted metadata in the virtual disk.

## Virtual disks are degraded on migrating the physical drives

**Likely Cause:** Rebuild in the new unit does not start automatically.

**Corrective Action:** Start the rebuild in the new unit through OpenManage.

## A physical disk was removed

1. Install the original physical disk if it was inadvertently removed, or replace it with a new or used physical disk.
2. Initialize a new physical disk. Perform a **Rescan** for all physical disks that are replaced.
3. If the physical disk was not removed, check that its cables are correctly installed.

## Physical or mechanical problems with the physical disk

1. Determine if the physical disk in the virtual disk has failed.
2. If a physical disk was recently removed and replaced, determine that it is correctly positioned in the backplane. Check the cable connections at the physical disk and at the system board.
3. Perform a **Rescan**

## The virtual disk has lost redundancy

One or more physical disks in the virtual disk may have failed, due to the failed physical disk or disks, the virtual disk is no longer maintaining redundant (mirrored or parity) data. The failure of an additional physical disk results in lost data.

1. Replace the physical disk or disks.
2. Rebuild the physical disk using Storage Management. See the applicable **Storage Management** screen at [Manuals](#).

## Corrupted metadata in the virtual disk

1. Delete the virtual disk that has the failed metadata.
2. Assign the physical disk as a hot spare to rebuild a redundant virtual disk.
3. To create a non-redundant virtual disk, delete and rebuilt the data on a virtual disk, and restore the data from a backup storage source.

## Cannot assign a dedicated hot spare to a virtual disk

If you cannot assign a dedicated hot spare to a virtual disk, check the following causes:

1. The RAID level does not allow a dedicated hot spare to be created.
2. The designated physical disk does not have sufficient capacity to be a dedicated hot spare.
3. The physical disk is already part of a virtual disk.
4. The physical disk are of different types.

### The RAID level does not allow a dedicated hot spare to be created

Hot spares cannot be created for Volume or RAID 0 virtual disks.

### The designated physical disk does not have sufficient capacity to be a dedicated hot spare

The capacity of the physical disk selected to be a dedicated hot spare must be equal to or larger than the capacity of the smallest physical disk in the virtual disk. For example, if the physical disk selected for a dedicated hot spare is 160 GB, and the physical disks in the virtual disk are 80 GB, 160 GB, and 500 GB, a dedicated hot spare can be assigned. That is because the physical disk selected for the dedicated hot spare is larger than the smallest (80 GB) physical disk in the virtual disk.

### The physical disk is already part of a virtual disk

A dedicated hot spare cannot be assigned to another virtual disk.

### The physical disk are of different types

The physical disk used as a dedicated hot spare must be the same type as the physical disks that are already part of the virtual disk. For example, if a virtual disk consists of SATA-II physical disks, the dedicated hot spare must be a SATA-II physical disk.

## Cannot create a global hot spare

If you cannot create a global hot spare, check the following causes:

1. There are no empty physical disks available or the physical disks have not been converted to RAID-capable disks.
2. The physical disk is already part of a virtual disk.
3. The physical disk assigned as the global hot spare has failed.
4. The physical disk assigned as the global hot spare is missing.

### There are no empty physical disks available or the physical disks have not been converted to RAID-capable disks

Install additional physical disks and convert them to a RAID-capable disk, If existing physical disks are **Non-RAID** they need to be converted to RAID-capable disks.

 **WARNING:** When a physical disk is converted to RAID Capable disks, all data on the physical disk is lost.

 **NOTE:** A physical disk with a **Non-RAID** status can be converted to a RAID-Capable disk, if desired, but it is no longer **Non-RAID** (Converting to RAID-Capable adds PERC S150 configuration information to the physical disk).

### The physical disk is already part of a virtual disk

A dedicated hot spare cannot be assigned to another virtual disk.

## The physical disk assigned as the global hot spare has failed

When prompted at system startup, press Ctrl+R to access the **BIOS Configuration Utility Ctrl+R**. In the **BIOS Configuration Utility Ctrl+R**, select **View Virtual Disk Details** and press Enter. Determine whether the physical disk that is designated as the global hot spare has a status of **Failed**.

1. Check to see if the physical disk is malfunctioning or is physically disconnected.
2. Select another physical disk as the global hot spare.

## The physical disk assigned as the global hot spare is missing

- Check to see if the physical disk was removed from the backplane or cable connection, or whether the cables from the controller to the physical disk are disconnected or faulty.
- Perform a rescan to verify that the physical disk is still missing.

## A dedicated hot spare fails

If a dedicated hot spare fails, check the following causes:

1. [The controller cannot communicate with the hot spare.](#)
2. [The dedicated spare is not visible in the BIOS Configuration Utility or is offline.](#)

## The controller cannot communicate with the hot spare

1. Check that the cable from the controller to the physical disk is connected properly.
2. Ensure that the physical disk is still assigned as a global or dedicated hot spare.
3. Determine if the physical disk assigned as the hot spare has failed.

## The dedicated spare is not visible in the BIOS Configuration Utility or is offline

1. Determine if the physical disk has been removed or has failed.
2. Check for a loose or bad cable.

## Failed or degraded virtual disk

The removal of one physical disk from a virtual disk causes:

1. A volume or RAID 0 virtual disk to change to **Failed** status.
2. A RAID 1 and RAID 5 virtual disk to change to **Degraded** status.
3. A RAID 10 virtual disk to change to **Degraded** status (when a physical disk is removed from one of the mirrored sets).  
Re-insert the removed physical disk and perform a Rescan of the virtual disk.

## Cannot create a virtual disk on selected physical disks

Determine whether these physical/virtual disks were migrated from a legacy controller with mixed RAID levels. If so, creating additional virtual disk on these physical disk is not allowed.

## RAID disk created from the NVMe PCIe SSDs not appearing in operating system environment, showing as partitioned disks

<b>Description</b>	RAID disk created in UEFI mode from the NVMe PCIe SSDs are not discoverable in the operating system mode.
<b>Corrective Action</b>	Ensure that the partitioned drives are not deleted. Install the PERC S160 driver to see the RAID disks. See <a href="#">Installing the drivers</a> for more information.

## Cannot perform an online capacity expansion or reconfigure on a virtual disk

Determine whether these physical/virtual disks were migrated from a legacy controller with mixed RAID levels. If so, online capacity expansion/reconfigure by adding physical disks on such a set of physical disks is not allowed.

## Unable to configure RAID on NVMe PCIe SSD using a third party RAID configuration utility

<b>Corrective Action</b>	Ensure that the NVMe is set on <b>Non RAID</b> mode. See <a href="#">Setting the NVMe PCIe SSDs to RAID mode</a> .
--------------------------	--

## S150 config driver is not installed after S150 DUP is run

<b>Description</b>	After you run S150 DUP, the S150 config driver is not installed along with the S150 IO driver.
<b>Corrective Action</b>	Rerun S150 DUP on the system to install the S150 config driver.

## S150 driver not identifying P4800 drives

<b>Description</b>	S150 driver does not identify P4800 drives when the system is in the <b>NVMe RAID Dell Qualified</b> mode.
<b>Corrective Action</b>	To use P4800 drive with S150, select the <b>NVMe RAID - All Drive</b> option from <b>NVMe RAID settings</b> in HII.

## S150 DUP update message is displayed only for SATA controllers

<b>Description</b>	After S150 DUP is launched, the update-related messages are displayed only for SATA controllers and not for NVMe drives. However, the update is applied to all applicable SATA and NVMe drives. The final <b>Reboot</b> page lists both SATA controllers and NVMe drives.
<b>Corrective Action</b>	This is an expected behavior and no action is required.



# Getting help

## Topics:

- [Recycling or End-of-Life service information](#)
- [Contacting Dell](#)

## Recycling or End-of-Life service information

Take back and recycling services are offered for this product in certain countries. If you want to dispose of system components, visit the Dell Recycle Worldwide website and select the relevant country.

## Contacting Dell

Dell provides online and telephone based support and service options. If you do not have an active internet connection, you can find Dell contact information on your purchase invoice, packing slip, bill or Dell product catalog. The availability of services varies depending on the country and product, and some services may not be available in your area. To contact Dell for sales, technical assistance, or customer service issues:

1. Visit the support site.
2. Select your country from the drop-down menu on the lower right corner of the page.
3. For customized support:
  - a. Enter the system Service Tag in the **Enter a Service Tag, Serial Number, Service Request, Model, or Keyword** field.
  - b. Click **Submit**.  
The support page that lists the various support categories is displayed.
4. For general support:
  - a. Select your product category.
  - b. Select your product segment.
  - c. Select your product.  
The support page that lists the various support categories is displayed.
5. For contact details of Dell Global Technical Support:
  - a. Click **Contact Technical Support**.
  - b. The **Contact Technical Support** page is displayed with details to call, chat, or e-mail the Dell Global Technical Support team.

## Documentation resources

This section provides information about the documentation resources for your system.

To view the document that is listed in the documentation resources table:

- From the Dell support site:
  1. Click the documentation link that is provided in the Location column in the table.
  2. Click the required product or product version.

 **NOTE:** To locate the product name and model, see the front of your system.

3. On the Product Support page, click **Manuals & documents**.
- Using search engines:
    - Type the name and version of the document in the search box.

**Table 15. Additional documentation resources for your system**

Task	Document	Location
Setting up your system	<p>For more information about installing and securing the system into a rack, see the Rail Installation Guide included with your rail solution.</p> <p>For information about setting up your system, see the <i>Getting Started Guide</i> document that is shipped with your system.</p>	<a href="#">PowerEdge Server Manuals</a>
Configuring your system	<p>For information about the iDRAC features, configuring and logging in to iDRAC, and managing your system remotely, see the Integrated Dell Remote Access Controller User's Guide.</p> <p>For information about understanding Remote Access Controller Admin (RACADM) subcommands and supported RACADM interfaces, see the RACADM CLI Guide for iDRAC.</p> <p>For information about Redfish and its protocol, supported schema, and Redfish Eventing implemented in iDRAC, see the Redfish API Guide.</p> <p>For information about iDRAC property database group and object descriptions, see the Attribute Registry Guide.</p> <p>For information about Intel QuickAssist Technology, see the Integrated Dell Remote Access Controller User's Guide.</p>	<a href="#">PowerEdge Server Manuals</a>
	<p>For information about earlier versions of the iDRAC documents.</p> <p>To identify the version of iDRAC available on your system, on the iDRAC web interface, click</p>	<a href="#">iDRAC Manuals</a>

**Table 15. Additional documentation resources for your system (continued)**

Task	Document	Location
	<p><b>? &gt; About.</b></p> <p>For information about updating drivers and firmware, see the Methods to download firmware and drivers section in this document.</p>	<p><a href="#">Drivers</a></p>
<p>Managing your system</p>	<p>For information about systems management software offered by Dell, see the Dell OpenManage Systems Management Overview Guide.</p>	<p><a href="#">OpenManage Documentation</a></p>
	<p>For information about setting up, using, and troubleshooting OpenManage, see the Dell OpenManage Server Administrator User's Guide.</p>	<p><a href="#">OpenManage Documentation</a></p>
	<p>For information about installing, using, and troubleshooting Dell OpenManage Enterprise, see the Dell OpenManage Enterprise User's Guide.</p>	<p><a href="#">OpenManage Documentation</a></p>
	<p>For information about partner programs enterprise systems management, see the OpenManage Connections Enterprise Systems Management documents.</p>	<p><a href="#">OpenManage Connections and Integrations</a></p>
<p>Understanding event and error messages</p>	<p>For information about the event and error messages generated by the system firmware and agents that monitor system components, go to <a href="http://qrl.dell.com">qrl.dell.com</a> &gt; <b>Look Up</b> &gt; <b>Error Code</b>, type the error code, and then click <b>Look it up</b>.</p>	<p><a href="#">PowerEdge Server Event and Error Messages</a></p>